

Hardware for Professionals

hepo

hepo

Distribution Products
Price List Quarter 1 - 2021

Index

Furniture Fittings	Page No.
Hinges	
Auto Closing Slide-on Regular Hinges	3
Auto Closing Slide-on Soft Close Hinges	4
Auto Closing Clip-on Soft Close Hinges	5
Flap Hinges	6
Butt Hinges	7-8
Drawer Slides	
Telescopic Channel (Regular)	9
Telescopic Channel (Silent)	10
Furniture Locks	11
Gas Spring	12
Stainless Steel Baskets & Kitchen Accessories	
Plain Basket	13
Baskets with Inbuilt Interior Organizer	13
Spice & Bottle Pull-Out	14
Dish Drainer	15
Cylinder Trolley	15
Detergent Holder Series	16
Square Bin Holder	16
Aluminum Profiles	17
Handles	18
Tower Bolt	19-20
Bed Fittings	21-22
Bathroom Accessories	23-26
Connecting Fittings	27-29

Screws	Page No.
Stainless Steel Screws	32
Carbon Steel Screws	33-35
Black Screws	36-37
Special Purpose Screws	38-41
Accessories	42

Furniture Fittings



Reliable Concealed Hinges: **Auto Closing Slide-on Regular Hinges & Auto Closing Slide-on Soft Close Hinges** with Auto close as well as with Soft close feature tested.



Heavy Duty Drawer Runners: **Hepo Telescopic Drawer Runners** With Options for Zinc Coated and Black Painted Tested & Certified for 50,000 cycles.



Durable **Gas Spring for Overhead Cabinets**: Suitable for wooden or aluminum framed shutter Flap weight (including handle) carrying capacity of 3.2 kg to 35 kg. Tested & Certified for 50,000 cycles.



Butt Hinge option for **Non Bearing (Riveted)** as well as **Railway (Welded) Hinges**: High Weight carrying capacity up to 40 kg (per pair) Tested & Warranted for 2 years of functionality.

Auto Closing Slide-on Regular Hinges

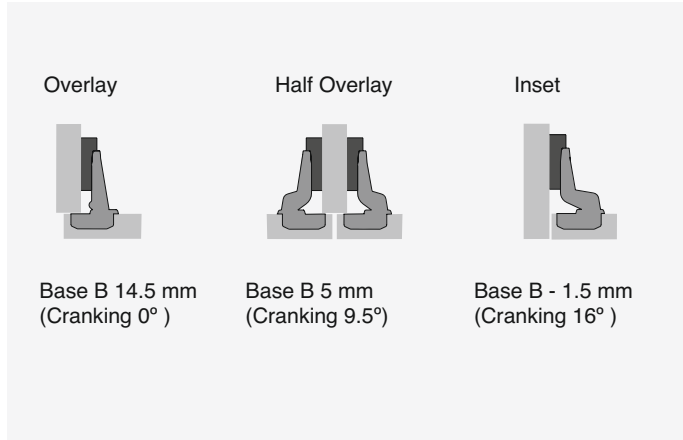

Technical details:

- ▶ Concealed hinge with slide on assembly
- ▶ **Quality classification under EN 15570, Level 1**
- ▶ Tested & Certified for 20,000 Cycles
- ▶ For door thickness 14 - 25 mm
- ▶ Opening angle: 105°
- ▶ Cup diameter 35 mm
- ▶ Cup depth 11.5 mm
- ▶ Integrated overlay adjustment + 0.5 mm / - 2.5 mm
- ▶ Integrated depth adjustment + 2 mm / - 2 mm
- ▶ Height adjustment at mounting plate
- ▶ Hinge arm material: Steel, Nickel plated

Minimum Reveal Per Door

Cup Distance C	Door thickness											
	14	15	16	17	18	19	20	21	22	23	24	25
3	0.04	0.12	0.23	0.38	0.59	0.85	1.18	1.61	2.22	2.96	3.76	4.6
4	0.04	0.11	0.22	0.37	0.56	0.81	1.11	1.49	1.99	2.63	3.36	4.15
4.5	0.04	0.11	0.22	0.36	0.55	0.79	1.08	1.45	1.91	2.5	3.2	3.96
5	0.04	0.11	0.21	0.36	0.54	0.77	1.06	1.41	1.84	2.39	3.04	3.77
6	0.04	0.1	0.2	0.34	0.52	0.74	1.01	1.33	1.73	2.21	2.79	3.46
7	0.04	0.1	0.2	0.33	0.5	0.71	0.97	1.27	1.64	2.07	2.59	3.2

Auto Closing Slide-on Regular Hinges with Mounting Plate (2 hole)

Technical details:

- ▶ Set Consists of:
 - 2 Hinges
 - 2 Mounting Plates (2 Hole)



Description (Retail Packing)	Unit	Article no.	PU	MRP/Pair
Auto Closing Slide-on Regular Hinges - 0 Crank with Mounting Plate (2 hole)	Pair	9284697.M2	100	79
Auto Closing Slide-on Regular Hinges - 9.5 Crank with Mounting Plate (2 hole)	Pair	9284698.M2	100	84
Auto Closing Slide-on Regular Hinges - 16 Crank with Mounting Plate (2 hole)	Pair	9284809.M2	100	89

Auto Closing Slide-on Regular Hinges with Mounting Plate (4 hole)

Technical details:

- ▶ Set Consists of:
 - 2 Hinges
 - 2 Mounting Plates (4 Hole)



Description (Retail Packing)	Unit	Article no.	PU	MRP/Pair
Auto Closing Slide-on Regular Hinges - 0 Crank with Mounting Plate (4 hole)	Pair	9284697.M4	100	79
Auto Closing Slide-on Regular Hinges - 9.5 Crank with Mounting Plate (4 hole)	Pair	9284698.M4	100	84
Auto Closing Slide-on Regular Hinges - 16 Crank with Mounting Plate (4 hole)	Pair	9284809.M4	100	89

Auto Closing Slide-on Soft Close Hinges

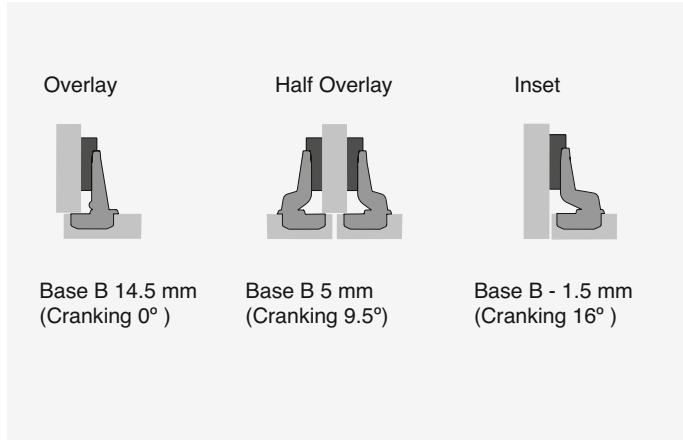

Technical details:

- ▶ Concealed hinge with slide on assembly
- ▶ **Quality classification under EN 15570, Level 1**
- ▶ Tested & Certified for 20,000 Cycles
- ▶ For door thickness 14 - 25 mm
- ▶ Opening angle: 105°
- ▶ Cup diameter 35 mm
- ▶ Cup depth 11.5 mm
- ▶ Integrated overlay adjustment + 0.5 mm / - 2.5 mm
- ▶ Integrated depth adjustment + 2 mm / - 2 mm
- ▶ Height adjustment at mounting plate
- ▶ Hinge arm material: Steel, Nickel plated

Minimum Reveal Per Door

Cup Distance C	Door thickness											
	14	15	16	17	18	19	20	21	22	23	24	25
3	0.04	0.12	0.23	0.38	0.59	0.85	1.18	1.61	2.22	2.96	3.76	4.6
4	0.04	0.11	0.22	0.37	0.56	0.81	1.11	1.49	1.99	2.63	3.36	4.15
4.5	0.04	0.11	0.22	0.36	0.55	0.79	1.08	1.45	1.91	2.5	3.2	3.96
5	0.04	0.11	0.21	0.36	0.54	0.77	1.06	1.41	1.84	2.39	3.04	3.77
6	0.04	0.1	0.2	0.34	0.52	0.74	1.01	1.33	1.73	2.21	2.79	3.46
7	0.04	0.1	0.2	0.33	0.5	0.71	0.97	1.27	1.64	2.07	2.59	3.2

Auto Closing Slide-on Soft Close Hinges with Mounting Plate (2 hole)

Technical details:

- ▶ Set Consists of:
 - 2 Hinges
 - 2 Mounting Plates (2 Hole)



Description (Retail Packing)	Unit	Article no.	PU	MRP/Pair
Auto Closing Slide-on Soft Close Hinges - 0 Crank with mounting plate (2 hole)	Pair	9284810.M2	100	149
Auto Closing Slide-on Soft Close Hinges - 9.5 Crank with mounting plate (2 hole)	Pair	9284811.M2	100	154
Auto Closing Slide-on Soft Close Hinges - 16 Crank with mounting plate (2 hole)	Pair	9284812.M2	100	159

Auto Closing Slide-on Soft Close Hinges with Mounting Plate (4 hole)

Technical details:

- ▶ Set Consists of:
 - 2 Hinges
 - 2 Mounting Plates (4 Hole)



Description (Retail Packing)	Unit	Article no.	PU	MRP/Pair
Auto Closing Slide-on Soft Close Hinges - 0 Crank with mounting plate (4 hole)	Pair	9284810.M4	100	149
Auto Closing Slide-on Soft Close Hinges - 9.5 Crank with mounting plate (4 hole)	Pair	9284811.M4	100	154
Auto Closing Slide-on Soft Close Hinges - 16 Crank with mounting plate (4 hole)	Pair	9284812.M4	100	159

Auto Closing Clip-on Soft Close Hinges



Technical details:

- Material: Steel Nickel plated
- Concealed hinge with Clip on assembly
- **Quality Classification under EN 15570, Level 1**
- Available with integrated soft closing option
- For door thickness: 16- 24 mm
- Open angle: up to 105 °
- Cup diameter: 35 mm
- Cup depth: 11.5 mm
- Both mounting plate available with 2 holes and 4 holes
- Tested for 20,000 functional cycles

C- value	Door Thickness									
	B	16	17	18	19	20	21	22	23	24
3		0.4	0.6	0.8	1.2	1.6	2.2	2.9	3.7	4.6
4		0.4	0.6	0.8	1.1	1.5	2.0	2.6	3.3	4.1
5		0.4	0.6	0.8	1.1	1.4	1.8	2.4	3.0	3.8
6		0.4	0.5	0.7	1.0	1.3	1.7	2.2	2.8	3.5
7		0.3	0.5	0.7	1.0	1.3	1.6	2.1	2.6	3.2

Auto Closing Clip-on Soft Close Hinges with Mounting Plate (2 Hole)



Technical Details:

Set Consists Of
2 Hinges
2 Mounting Plates (2 Hole)
2 Arm Cover

Description (Retail Packing)	Unit	Article no.	PU	MRP/ Pair
Clip on Silent Hinges - 0 Crank - with Damper, Mounting Plate & Arm cover	Pair	9290745.M2	100	232
Clip on Silent Hinges - 9.5 Crank - with Damper, Mounting Plate & Arm cover	Pair	9290746.M2	100	238
Clip on Silent Hinges - 16 Crank - with Damper, Mounting Plate & Arm cover	Pair	9290747.M2	100	244

Auto Closing Clip-on Soft Close Hinges with Mounting Plate (4 Hole)



Technical Details:

Set Consists Of
2 Hinges
2 Mounting Plates (4 Hole)
2 Arm Cover

Description (Retail Packing)	Unit	Article no.	PU	MRP/ Pair
Clip on Silent Hinges - 0 Crank - with Damper, Mounting Plate & Arm cover	Pair	9290745.M4	100	232
Clip on Silent Hinges - 9.5 Crank - with Damper, Mounting Plate & Arm cover	Pair	9290746.M4	100	238
Clip on Silent Hinges - 16 Crank - with Damper, Mounting Plate & Arm cover	Pair	9290747.M4	100	244

Flap Hinges



- ▶ Flap hinge for overlay flaps
- ▶ Separate installation of bottom panel and flap element
- ▶ Flap alignment through adjustment of height, sides and depth
- ▶ Same drilling sizes in bottom panel and flap elements
- ▶ Hole drilling concealed by rim on both parts
- ▶ Without height adjustment, bottom panel and flap are flush on the inside when open
- ▶ Can only be used in conjunction with flap stays
- ▶ Material Used: Zinc Alloy, nickel plated

Set Includes: 1 Flap Hinge with 6 Screws(M3*15)

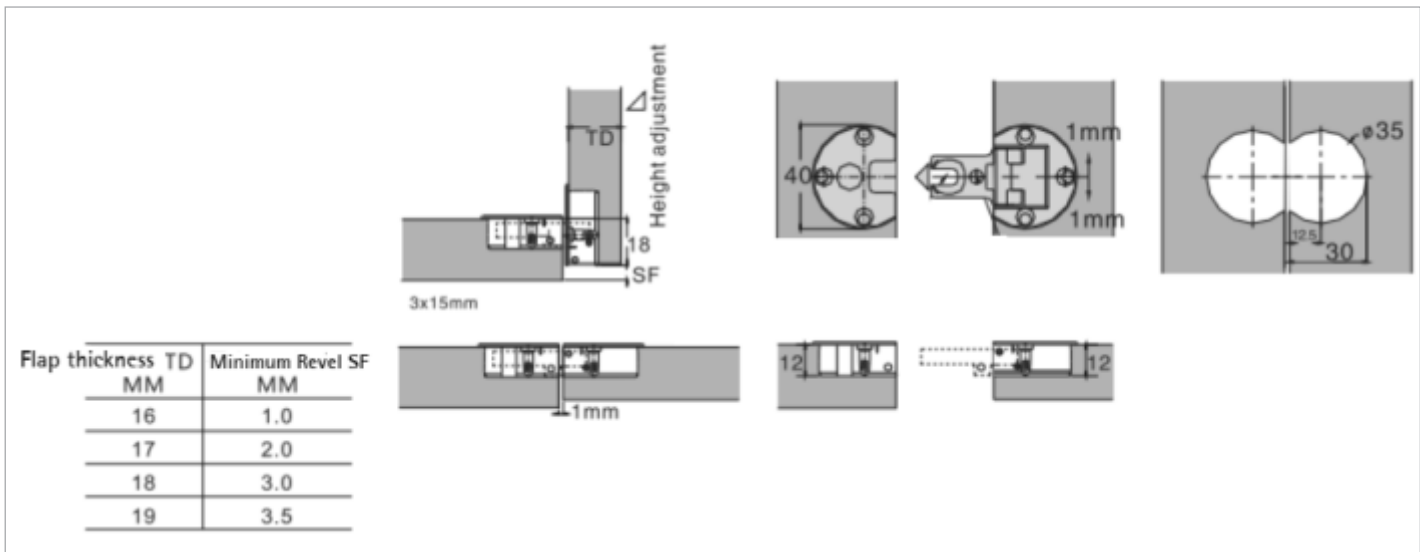

Description	Unit	Article No.	PU	MRP/Pc
Hepo Flap Hinge	Pc	9297879	200	195



Hepo Butt Hinges

Riveted Type

Stainless Steel Riveted Type



Features:

- ▶ Loading Capacity up to 40 kg / pair
- ▶ DIN Left / Right Usable
- ▶ Mostly preferred for Steel / wood & Aluminum profile doors
- ▶ Area of application: Light Main and Internal doors
- ▶ Warranty : 2 years



Technical details:

- ▶ Ø Barrel diameter: 12 mm
- ▶ Leaf thickness: 2.5 mm
- ▶ Milling for doors: 2 / 2.5 mm
- ▶ Available Sizes: 3"x2"x2 mm / 4"x3"x2.5 mm / 5"x3"x2.5 mm
- ▶ Base Material: Stainless Steel
- ▶ Edge: Square
- ▶ Finish Available: Stainless Steel Satin

S.No.	Description	Size mm (inch)	Unit	Article No.	PU	MRP / Pair
1	SS 76x50x2 mm (3"x2"x2 mm) (Hole Pattern: C)		Pair	9268550	01	265
2	SS 102x76x2.5 mm (4"x3"x2.5 mm) (Hole Pattern: Z)		Pair	9268395	01	373
3	SS 127x76x2.5 mm (5"x3"x2.5 mm) (Hole Pattern: Z)		Pair	9268396	01	435

Recommended Stainless Steel Screws:



S.No.	Description	Size mm (inch)	Unit	Article No.	PU	MRP / Pc
1	SS screw CSK PZ2 5.0X30mm		Pc	9277146	500	3.78
2	SS screw CSK PZ2 5.0X40mm		Pc	9277147	400	4.82

Butt Hinges

Welded Type

hepo



Stainless Steel Welded Type (Railway Hinges)



Features:

- ▶ Recommended for wooden / aluminium / framed doors.
- ▶ Area of application: Main & Internal doors of an apartment / building
- ▶ Weight capacity: 40 Kg/Pair
- ▶ Warranty : 2 years

Technical details:

- ▶ Leaf Thickness - 1.7 / 2 / 2.5 mm
- ▶ Edge - Square Edge
- ▶ Pin Dia - 4 & 5.6 mm
- ▶ DIN Leaf/Right Usage
- ▶ Available Sizes - 3x14 / 4x14 / 5x14 / 3x12 / 4x12 / 5x12
- ▶ Finish Available - SS Satin
- ▶ No. of Holes - 6/8

S.No.	Description Size mm (inch)	Unit	Article No.	PU	MRP/ Pair
1	Butt Hinge SS 75x48x2 mm (3"x2"x2 mm) (3x14)	Pair	9278616	20	135
2	Butt Hinge SS 100x58x2 mm (4"x2.5"x2 mm) (4x14)	Pair	9278617	12	215
3	Butt Hinge SS 125x64x2 mm (5"x2.5"x2 mm) (5x14)	Pair	9278618	10	280
4	Butt Hinge SS 75x50x2.5 mm (3"x2"x2.5 mm) (3x12)	Pair	9278619	20	165
5	Butt Hinge SS 100x60x2.5 mm (4"x2.3"x2.5 mm) (4x12)	Pair	9278620	12	250
6	Butt Hinge SS 125x67x2.5 mm (5"x2.6"x2.5 mm) (5x12)	Pair	9278621	10	330

Recommended Stainless Steel Screws:



S.No.	Description Size mm (inch)	Unit	Article No.	PU	MRP / Pc
1	SS screw CSK PZ2 5.0X30mm	Pc	9277146	500	3.78
2	SS screw CSK PZ2 5.0X40mm	Pc	9277147	400	4.82

Telescopic Channel (Regular)

Heavy Duty Drawer Runners



Telescopic Channel (Regular) - Zinc / Black



Features:

- ▶ Heavy Duty full extension runner
- ▶ Guaranteed up to 50,000 Opening-closing cycles
- ▶ Better Designed Tracks creates Ease of operation & Better dynamic Load Behaviour
- ▶ Loading Capacity: 45 kg

Nominal length / drawer length NL mm	Minimum carcass depth D mm	Hole spacing b1 mm	Hole spacing b2 mm	Hole spacing b3 mm	Hole spacing b4 mm	Hole spacing b5 mm	Hole spacing C mm
250	254						192
300	304	96					242
350	354	96					292
400	404	96	96				342
450	454	96	128				392
500	504	96	128	64			442
550	554	96	128	64	32	32	492
600	604	96	128	96	32	32	542

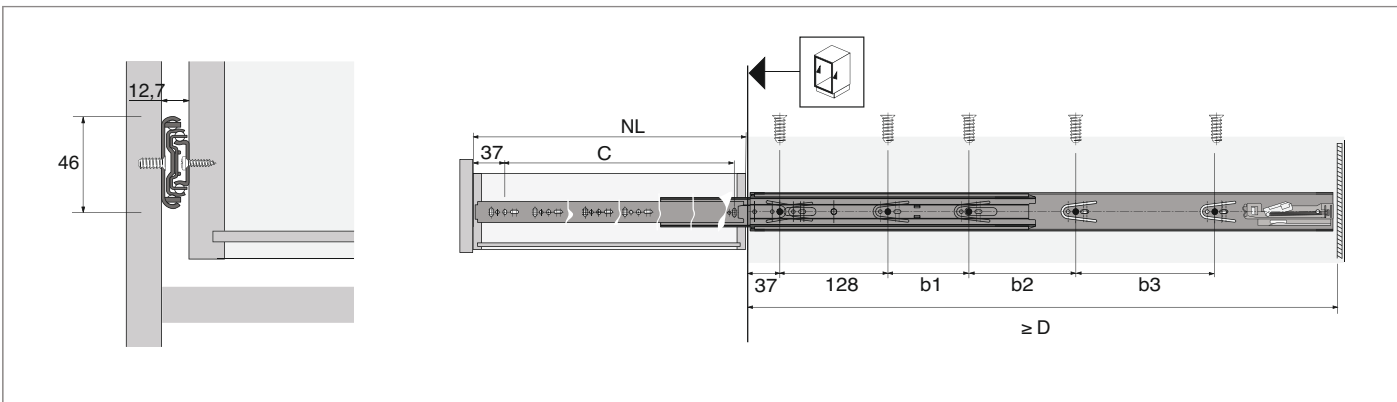

Description		Size	Unit	Article no	PU	MRP / Pair
Hepo Telescopic Channel/Zinc		10"- 250 mm	Set	9284648	10	296
Hepo Telescopic Channel/Zinc		12"- 300 mm	Set	9284699	10	319
Hepo Telescopic Channel/Zinc		14"- 350 mm	Set	9284700	10	342
Hepo Telescopic Channel/Zinc		16"- 400 mm	Set	9284701	10	363
Hepo Telescopic Channel/Zinc		18"- 450 mm	Set	9284702	10	386
Hepo Telescopic Channel/Zinc		20"- 500 mm	Set	9284703	10	399
Hepo Telescopic Channel/Zinc		22"- 550 mm	Set	9284704	10	449
Hepo Telescopic Channel/Zinc		24"- 600 mm	Set	9284622	10	499

Description		Size	Set	Article no	PU	MRP / Pair
Hepo Telescopic Channel /Black		10"- 250 mm	Set	9284705	10	296
Hepo Telescopic Channel /Black		12"- 300 mm	Set	9284706	10	319
Hepo Telescopic Channel/Black		14"- 350 mm	Set	9284707	10	342
Hepo Telescopic Channel/Black		16"- 400 mm	Set	9284708	10	363
Hepo Telescopic Channel/Black		18"- 450 mm	Set	9284709	10	386
Hepo Telescopic Channel/Black		20"- 500 mm	Set	9284710	10	399
Hepo Telescopic Channel/Black		22"- 550 mm	Set	9290299	10	449
Hepo Telescopic Channel/Black		24"- 600 mm	Set	9290297	10	499

Telescopic Channel (Silent)

Heavy Duty Drawer Runners with Silent System



Telescopic Channel (Silent)



Features:

- ▶ Full extension ball bearing drawer slide with Silent System
- ▶ Finish: Zinc plated in light blue
- ▶ Guaranteed up to 40,000 functional cycles

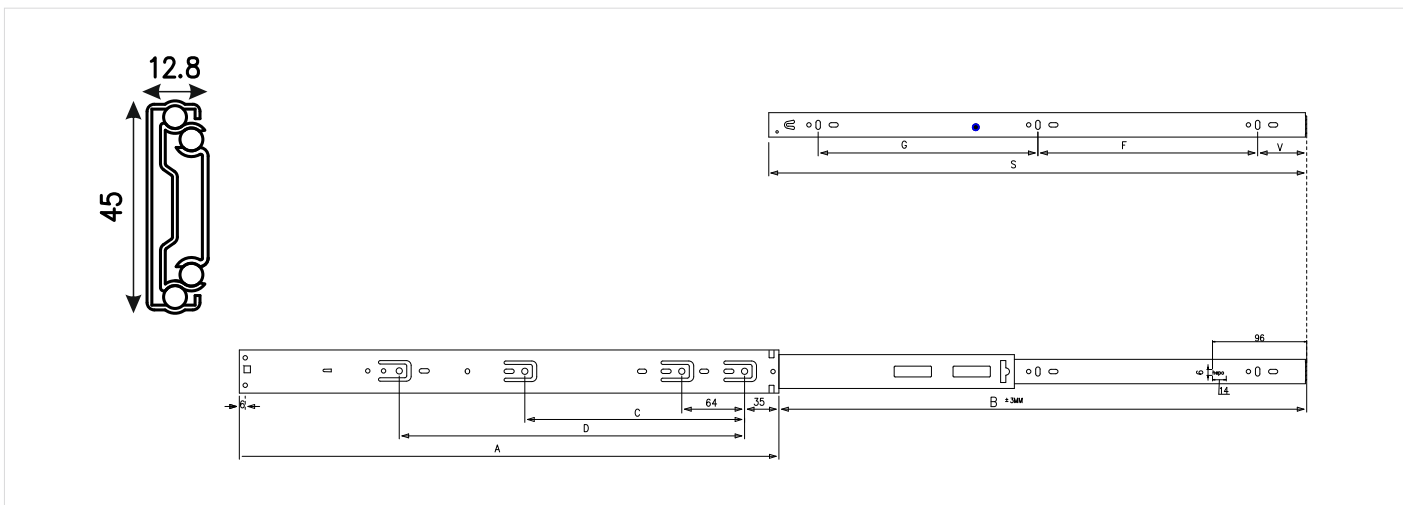

Length	(Hole pattern)							
	A	B	C	D	V	F	G	S
300	300	300			50	96	96	283
350	350	350		160	50	128	96	333
400	400	400		224	50	128	160	383
450	450	450	224		50	160	160	433
500	500	500	224	320	50	160	224	483

Description	Size	Unit	Article no	PU	MRP / Pair
Hepo Telescopic Channel with silent system / Zinc	300 mm	Set	9293951	10	549
Hepo Telescopic Channel with silent system / Zinc	350 mm	Set	9293903	10	599
Hepo Telescopic Channel with silent system / Zinc	400 mm	Set	9293904	10	639
Hepo Telescopic Channel with silent system / Zinc	450 mm	Set	9293905	10	669
Hepo Telescopic Channel with silent system / Zinc	500 mm	Set	9293906	10	699
Hepo Telescopic Channel with silent system / Zinc	550 mm	Set	9295964	10	779

Furniture Locks

Economic Multipurpose Locks



Economic Multipurpose Locks

Multipurpose locks throw a bolt / tongue out allowing the door to be locked when closed. This locks can be used in a number of applications particularly in any cabinet & drawer construction. It can secure the cabinet door and requires a key for the cabinet to be opened. These locks are ideal for office environments as they allow to lock private & confidential papers securely. In addition to this, they are also suitable for homes & can keep valuables, private & confidential papers or snacks locked securely in your cupboard out of reach of young children!

Technical details:

- ▶ Adjustable for left/right-hand operation
- ▶ Available for 22 mm panel thickness
- ▶ Complete with rosette
- ▶ Available with max. 120 Key Combinations
- ▶ Available with 2 iron keys
- ▶ Tested for 30000 functional cycles
- ▶ Material: Zinc & Steel

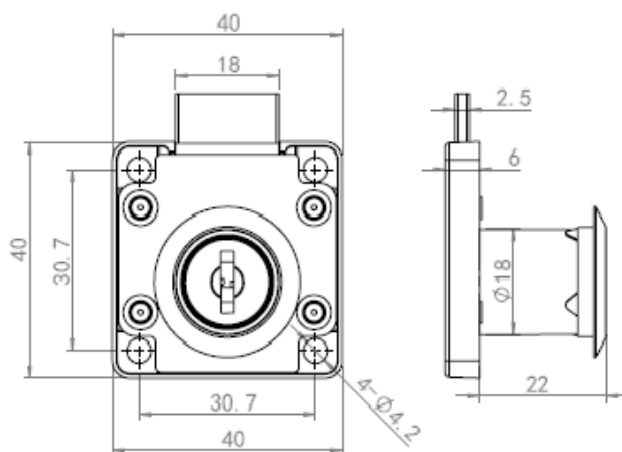

Set Comprises

Sr No:	Description	Quantity
1	Based Cover	1
2	Front Cover	1
3	Bolt	1
4	Cylinder Cover	1
5	Cylinder	1
6	Cylinder Front Cover	1
7	Ring	1

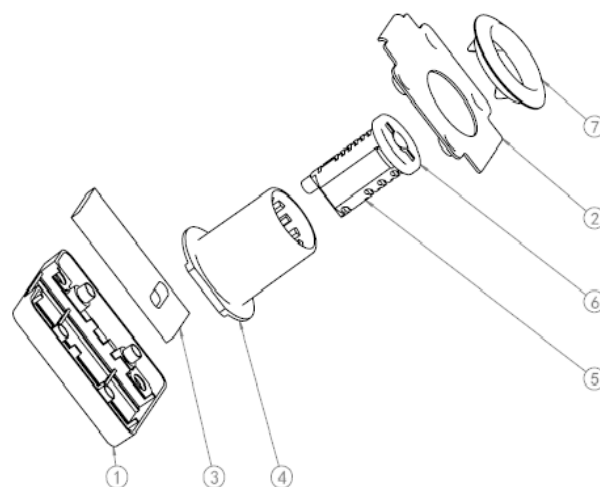

Description	Unit	Article no	PU	MRP/ PC
Economic MP Lock 120 KC, 22 mm	Pc	9287295	120	127
Economic MP Lock 120 KC, 32 mm	Pc	9291595	120	148

Gas Spring

Guaranteed for 50,000 cycles



Gas Spring



- ▶ Suitable for wooden or aluminum framed shutter
- ▶ Needs auto-closing hinges fitted in the shutter for operation
- ▶ Flap weight (including handle) carrying capacity: 3.2 Kg to 35 kg
- ▶ Spring force : 80N-350N
- ▶ Gas Spring dimension : 9 inch (270 mm) / 12 inch (301 mm)
- ▶ Performance temperature range of +45°C to -25°C
- ▶ **Tested for 50,000 cycles by SGS, Switzerland**

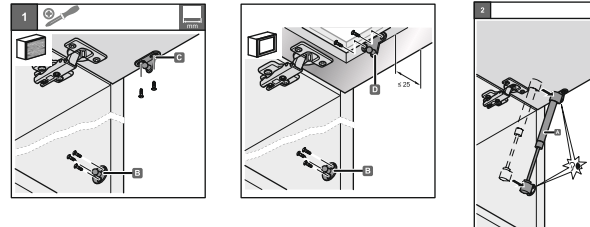

Gas Spring dimension : 9 inch (270 mm)

Gas Spring dimension : 12 inch (301 mm)

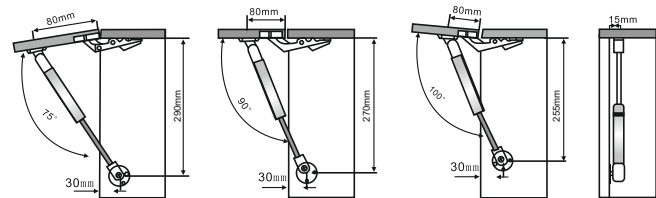
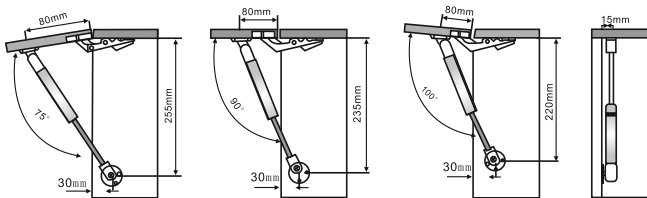

Maximum Door Weight

(kg) \ (mm)	75°				90°				100°			
	300	400	500	600	300	400	500	600	300	400	500	600
60N	3.3kg	2.8kg	2kg	1.8kg	3.1kg	2.6kg	1.8kg	1.4kg	2.9kg	2.4kg	1.6kg	1.2kg
80N	4.3kg	3.5kg	2.6kg	2kg	4.1kg	3.3kg	2.4kg	1.8kg	3.9kg	3.1kg	2.2kg	1.6kg
100N	5kg	4.1kg	3.2kg	2.5kg	4.8kg	4kg	3kg	2.3kg	4.6kg	3.8kg	2.8kg	2kg
120N	5.7kg	4.7kg	3.8kg	3kg	5.5kg	4.5kg	3.4kg	2.8kg	5.3kg	4.3kg	3.3kg	2.6kg
150N	6.5kg	5.5kg	4.7kg	3.7kg	6.2kg	5.3kg	4.5kg	3.5kg	6kg	5.1kg	4.3kg	3.3kg
200N	9.3kg	7.5kg	5.5kg	4.8kg	9.1kg	7.3kg	5.3kg	4.6kg	8.9kg	7.1kg	5.1kg	4.4kg
250N		9.7kg	8kg	5.5kg		9.5kg	7.8kg	5.3kg		9.3kg	7.6kg	5.1kg
300N		12.2kg	9.3kg	7.7kg		12kg	9.1kg	7.5kg		11.8kg	8.9kg	7.3kg
350N		15.8kg	10kg	9.2kg		15.6kg	9.8kg	9kg		15.3kg	9.6kg	8.7kg

Gas Springs for Overheads - 9 inch	Unit	Article No.	PU	MRP/Pair	Gas Springs for Overheads - 12 inch	Unit	Article No.	PU	MRP/Pair
Gas spring Capacity - 8 KG / 9 inch	Pair	9289456	1	278	Gas spring Capacity - 8 KG / 12 inch	Pair	9289474	1	338
Gas spring Capacity - 10 KG / 9 inch	Pair	9289457	1	278	Gas spring Capacity - 10 KG / 12 inch	Pair	9289475	1	338
Gas spring Capacity - 12 KG / 9 inch	Pair	9289458	1	278	Gas spring Capacity - 12 KG / 12 inch	Pair	9289476	1	338
Gas spring Capacity - 15 KG / 9 inch	Pair	9289469	1	278	Gas spring Capacity - 15 KG / 12 inch	Pair	9289477	1	338
Gas spring Capacity - 20 KG / 9 inch	Pair	9289470	1	278	Gas spring Capacity - 20 KG / 12 inch	Pair	9289478	1	338
Gas spring Capacity - 25 KG / 9 inch	Pair	9289471	1	278	Gas spring Capacity - 25 KG / 12 inch	Pair	9289479	1	338
Gas spring Capacity - 30 KG / 9 inch	Pair	9289472	1	278	Gas spring Capacity - 30 KG / 12 inch	Pair	9289481	1	338
Gas spring Capacity - 35 KG / 9 inch	Pair	9289473	1	278	Gas spring Capacity - 35 KG / 12 inch	Pair	9289482	1	338

Stainless Steel Wire Baskets

Stainless steel wire baskets with chrome plating

Compatible with Telescopic Channels



Plain Basket



- ▶ Unique sleek elegant design
- ▶ 30 kg weight carrying capacity
- ▶ Convenient to store different size packs of your kitchen

Article No.	Size WxDxH: mm(inch)	Unit	PU	MRP/Pc
9280319	380x500x100 (15"x20"x4")	Pc	6	1,492
9280320	380x500x150 (15"x20"x6")	Pc	4	1,809
9280351	380x500x200 (15"x20"x8")	Pc	3	2,057
9280354	430x500x100 (17"x20"x4")	Pc	6	1,560
9280355	430x500x150 (17"x20"x6")	Pc	4	1,843
9280356	430x500x200 (17"x20"x8")	Pc	3	2,251
9280359	480x500x100 (19"x20"x4")	Pc	6	1,642
9280360	480x500x150 (19"x20"x6")	Pc	4	1,982
9280361	480x500x200 (19"x20"x8")	Pc	3	2,354
9280364	530x500x100 (21"x20"x4")	Pc	6	1,518
9280365	530x500x150 (21"x20"x6")	Pc	4	1,822
9280366	530x500x200 (21"x20"x8")	Pc	3	2,126

Baskets with Inbuilt Interior Organizer

Cup & Saucer Basket



- ▶ Sleek design for perfect arrangement of cup & saucers
- ▶ Recommended shutter height min. 180 mm
- ▶ 500 mm depth can hold 18 no. of saucers
380 mm width can hold 8 no. of cups & 530 mm can hold 16 no. of cups respectively

Article No.	Size WxDxH: mm(inch)	Unit	PU	MRP/Pc
9280352	380x500x100 (15"x20"x4")	Pc	6	1,866
9280357	430x500x100 (17"x20"x4")	Pc	6	2,089
9280362	480x500x100 (19"x20"x4")	Pc	6	2,538
9280367	530x500x100 (21"x20"x4")	Pc	6	2,538

Thali Basket

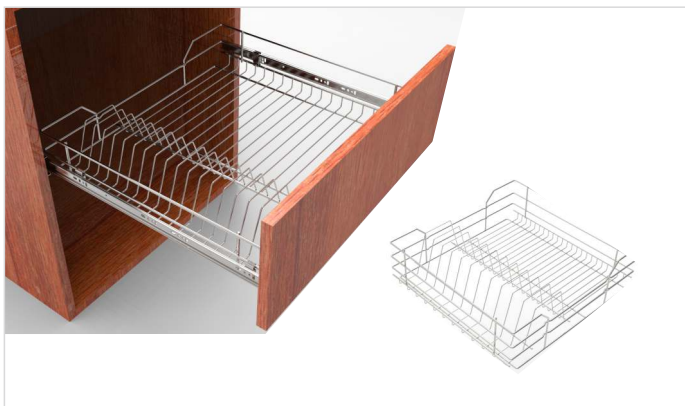

- ▶ Compact design to store thalis in an organized manner
- ▶ Recommended shutter height min. 360 mm
- ▶ 500 mm depth can hold 11 no. of thalis

Article No.	Size WxDxH: mm(inch)	Unit	PU	MRP/Pc
9280353	380x500x150 (15"x20"x6")	Pc	4	2,237
9280358	430x500x150 (17"x20"x6")	Pc	4	2,425
9280363	480x500x150 (19"x20"x6")	Pc	4	2,640
9280368	530x500x150 (21"x20"x6")	Pc	4	2,698

Stainless Steel Kitchen Accessories

Spice & Bottle Pull-Out



Spice Pull-Out



Features:

- ▶ Available with product Dimensions (WxDxH)mm: 94x500x575 mm, 134x500x575 mm, 234x500x575 mm
- ▶ Suitable for cabinet widths 150 mm, 200 mm & 300 mm
- ▶ Compatible with KA telescopic runner only
- ▶ Available with precise adjustment of front fascia
- ▶ Suitable for mounting on the left/right side (W94 & W134 only) or diagonally (W134 & W234 only)
- ▶ Package Contain: 1 Wire Basket, 4 Fascia Clamps, 8 Fascia Screws
- ▶ Weight carrying capacity up to 22.5 Kg (W94), 26.5 Kg (W134) and 30 Kg (W234) with KA telescopic runner
- ▶ Material: Stainless Steel
- ▶ Finish: Chrome Plated
- ▶ 5 years replacement warranty against rusting
- ▶ Available with Food grade certification for wire basket

Description	Size (WxDxH) mm	Unit	Article no	PU	MRP/Pc
HEPO Spice Pull-Out W94	94x500x575	Pc	9292096	06	2,444
HEPO Spice Pull-Out W134	134x500x575	Pc	9292097	04	2,736
HEPO Spice Pull-Out W234	234x500x575	Pc	9292098	02	3,485

Bottle Pull-Out



Features:

- ▶ Product Dimensions (WxDxH)mm: 94x500x460mm, 134x500x460mm, 234x500x460mm
- ▶ Suitable for cabinet widths 150mm, 200mm & 300mm
- ▶ Compatible with KA telescopic runner only
- ▶ Available with precise adjustment of front fascia
- ▶ Suitable for mounting on the left/right side (W94 & W134 only) or diagonally (W134 & W234 only)
- ▶ Package Contain: 1 Wire Basket, 4 Fascia Clamps, 8 Fascia Screws
- ▶ Weight carrying capacity up to 22.5 Kg (W94), 26.5 Kg (W134) and 30 Kg (W234) with KA telescopic runner
- ▶ Material: Stainless Steel
- ▶ Finish: Chrome Plated
- ▶ 5 years replacement warranty against rusting
- ▶ Available with Food grade certification for wire basket

Description	Size (WxDxH) mm	Unit	Article no	PU	MRP/Pc
HEPO Bottle Pull-Out W94	94x500x460	Pc	9292100	06	1,719
HEPO Bottle Pull-Out W134	134x500x460	Pc	9292101	04	1,913
HEPO Bottle Pull-Out W234	234x500x460	Pc	9292102	02	2,401

Stainless Steel Kitchen Accessories

Portable Dish Drainer & Dish Drainer for Overhead Unit
Cylinder Trolley



Portable Dish Drainer



- ▶ Convenience of modular concept
- ▶ Can hold 5 Thali & 9 Plates
- ▶ Bottom mesh for holding utensils like spoons, forks, cups, bowls, glass, knives etc.
- ▶ Unique PVC collection tray
- ▶ Unique slotted plastic bottom for water draining
- ▶ Order PVC Tray & Plastic bottom separately
- ▶ Width 505 mm / Depth 340 mm / Height 330 mm
- ▶ Finish- Chrome Plated



Collecting PVC Tray 600 mm



- ▶ Optional PVC tray for water collecting
- ▶ Width 540 mm / Depth 270 mm / Height 25 mm
- ▶ Finish- Silver Plastic

Acrylic sheet Portable Drainer



- ▶ Optional slotted plastic bottom for water draining
- ▶ Width 445 mm / Depth 230 mm / Thickness 3 mm
- ▶ Finish- White Plastic

Sr.no.	Description	Article no.	Unit	PU	MRP/Pc
1.	Portable Dish Drainer	9267212	Pc	1	2,530
2.	Collecting PVC Tray 600mm	9190453	Pc	1	295
3.	Acrylic sheet Portable Drainer	9267309	Pc	1	420

Dish Drainer for Overhead Unit



- ▶ Convenience of modular concept
- ▶ Available for two different cabinets width 600 mm & 900 mm
- ▶ Two layers of dish drainer & cutlery drainer
- ▶ Unique PVC collecting tray
- ▶ 600 mm can take 6 Thali / 8 Plates (of ø 280 mm)
- ▶ 900 mm can take 9 Thali / 15 Plates (of ø 280 mm)
- ▶ Combines convenience with unmatched stability & strength
- ▶ Sturdy stainless steel wire basket structure
- ▶ Can be mounted very easily
- ▶ Finish: Chrome Plated
- ▶ Made of stainless steel wire



Description	Article no.	Unit	PU	MRP/Pc
For 600 mm	9206160	Set	1	4131
For 900 mm	9206161	Set	1	5751

Cylinder Trolley



- ▶ Light weight but sturdy
- ▶ Smooth motion with castors
- ▶ Locking mechanism in two castors, for stability
- ▶ Can easily take load of filled gas cylinder
- ▶ Low height for easy loading of cylinder
- ▶ Finish: Chrome Plated
- ▶ Made of stainless steel wire



Description	Article no.	Unit	PU	MRP/Pc
Cylinder Trolley	9210445	Pc	1	1,396

Stainless Steel Kitchen Accessories

Detergent Holder Series & Square Bin Holder



Detergent Holder Series



- ▶ Unique Plastic sheet to avoid spillages and any damages to wire due to detergents / chemicals kept
- ▶ Material kept more stable as plastic sheet plain surface compared to wire mesh
- ▶ Light weight but sturdy structure, as made of thick wire
- ▶ Bigger shelves to accommodate various bottle sizes
- ▶ Easy installation, with fixing at only three points
- ▶ Finish: Chrome Plated
- ▶ Made of stainless steel wire
- ▶ Recommended shutter width 450 mm

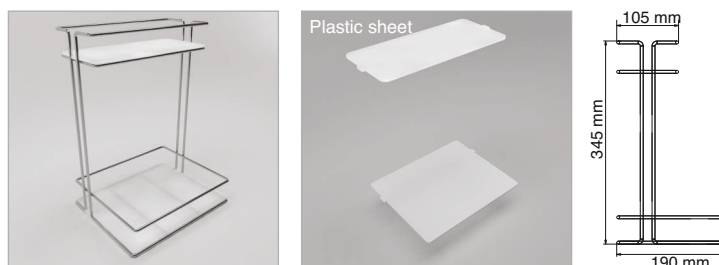

Description	Article no.	Unit	PU	MRP/Pc
Detergent Holder Series	9197058	Pc	1	1,838

Square Bin Holder



- ▶ Light weight but sturdy structure, as made of thick wire
- ▶ Major contribution in green environment management
- ▶ Finish : Chrome Plated



Technical Details

- ▶ Min required cabinet width- 350 mm
- ▶ Min. internal cabinet depth- 505 mm
- ▶ Preferable to use with Hinges 95°
- ▶ Bin capacity - 8 L
- ▶ Easy installation, with fixing at only two points

Note

- ▶ Lid is available in green & grey finish

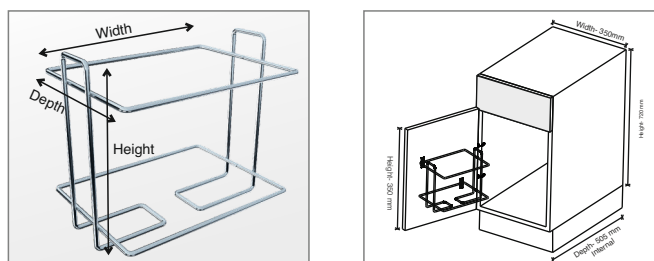

Description	Width x depth x height mm	Article no.	Unit	PU	MRP/Pc
Square Bin Holder	235 x 170x 205	9269984	Set	1	838
8L Bin	152 x 225x 295	9132377	Set	1	1,197
8L Lid (Grey)	152 x 225x 21	9132384	Set	1	496
8L Lid (Green)	152 x 225x 21	9132382	Set	1	496

Aluminium Profile

Silver Anodized Aluminium Profile for Furniture Fronts



Handle Profile

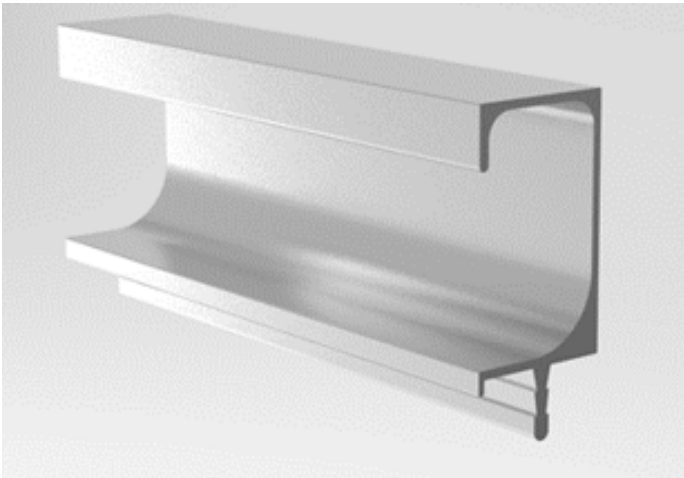

G-Handle Profile

- ▶ Material Used: Anodized Aluminium
- ▶ For wood thickness 19 mm
- ▶ Profile Height: 35 mm
- ▶ Profile Length: 3000 mm
- ▶ Finish: Silver
- ▶ Supplied with sealing strip for 4 mm glass

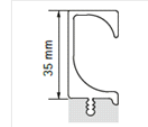

Description	Size (W)	Unit	Article No.	PU	MRP/Pc
G Handle Profile 3000 mm SA	35 mm X 19.5 mm	Pc	5211017	8	949

Straight Frame Profile

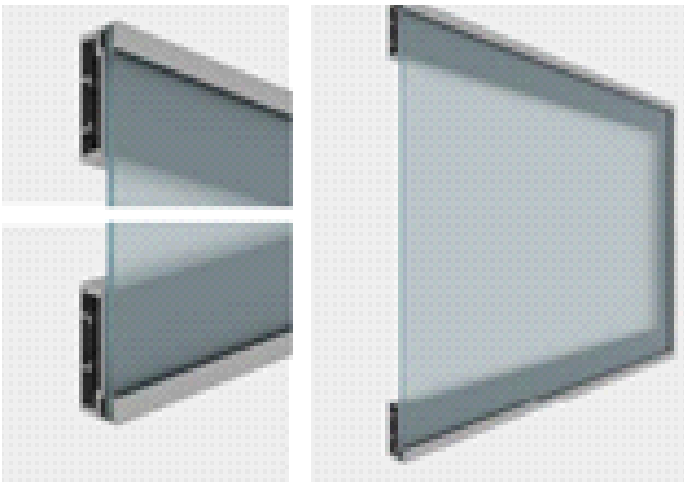

45 mm Straight Frame Profile

- ▶ Material Used: Anodized Aluminium
- ▶ Profile Width: 45 mm
- ▶ Profile Length: 3000 mm
- ▶ For glass thickness: 4 mm
- ▶ Finish: Silver
- ▶ Supplied with sealing strip for 4 mm glass

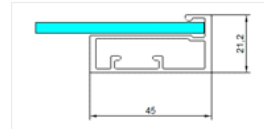

Description	Size (W)	Unit	Article No.	PU	MRP/Pc
Alu Profile 45 mm Straight 3000 mm SA	45 mm	Pc	5211018	4	1329

Straight Frame Profile with Handle



45 mm Straight Frame Profile with F Handle

- ▶ Material Used: Anodized Aluminium
- ▶ Profile Width: 45 mm
- ▶ Profile Length: 3000 mm
- ▶ For glass thickness: 4 mm
- ▶ Finish: Silver
- ▶ Supplied with sealing strip for 4 mm glass

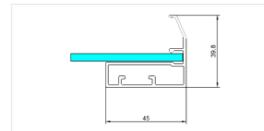







Description	Size (W)	Unit	Article No.	PU	MRP/Pc
Alu Profile 45 mm Straight with F Handle 3000 mm SA	45 mm	Pc	5211019	4	1519



Description	Unit	Article No.	PU	MRP/Set
Angle Connector Set (For all aluminum profiles) 1 Set Consists of 4 connectors & 8 screws	Set	13684	20	110

Handles



Sr. No.	Description	Finish	Article No.	Hole Distance	Unit	PU	MRP/Pc
1.		Nickel Matt	1180122	96	Pc	200	87
		Nickel Matt	1180121	128	Pc	150	135
2.		Nickel Matt	1180167	96	Pc	200	92
		Nickel Matt	1180166	128	Pc	125	136
3.		Nickel Matt	1161173	96	Pc	60	82
		Nickel Matt	1161167	128	Pc	50	122
4.		Nickel Matt	9220976	96	Pc	50	69
		Nickel Matt	9220978	128	Pc	50	108
5.		Bright Chrome	9220975	96	Pc	50	62
		Bright Chrome	9220977	128	Pc	50	99
6.		Nickel Matt	9220980	96	Pc	50	64
		Nickel Matt	9220982	128	Pc	50	112
7.		Bright Chrome	9220979	96	Pc	50	58
		Bright Chrome	9220981	128	Pc	50	103

Note: For more handles refer to Handlesfor99.com

Tower Bolt

Aluminium Tower Bolt For Doors





Sr. No.		Description	Material	Finish	Rod dia. (in mm)	Article No.	Size (in mm)	Unit	PU	MRP/Pc
1		Towerbolt ALU-D18	Aluminium	Stainless Steel	9.5	9291322	100	Pc	12	158
2		Towerbolt ALU-D18	Aluminium	Stainless Steel	9.5	9291323	150	Pc	12	198
3		Towerbolt ALU-D18	Aluminium	Stainless Steel	9.5	9291324	200	Pc	12	235
4		Towerbolt ALU-D18	Aluminium	Stainless Steel	9.5	9291325	250	Pc	12	278
5		Towerbolt ALU-D18	Aluminium	Stainless Steel	9.5	9291326	300	Pc	12	322
1		Towerbolt ALU-D18	Aluminium	Antique Brass	9.5	9291327	100	Pc	12	195
2		Towerbolt ALU-D18	Aluminium	Antique Brass	9.5	9291328	150	Pc	12	240
3		Towerbolt ALU-D18	Aluminium	Antique Brass	9.5	9291329	200	Pc	12	285
4		Towerbolt ALU-D18	Aluminium	Antique Brass	9.5	9291330	250	Pc	12	335
5		Towerbolt ALU-D18	Aluminium	Antique Brass	9.5	9291331	300	Pc	12	385
1		Towerbolt ALU-D25	Aluminium	Stainless Steel	9.5	9291332	100	Pc	12	175
2		Towerbolt ALU-D25	Aluminium	Stainless Steel	9.5	9291333	150	Pc	12	220
3		Towerbolt ALU-D25	Aluminium	Stainless Steel	9.5	9291334	200	Pc	12	260
4		Towerbolt ALU-D25	Aluminium	Stainless Steel	9.5	9291335	250	Pc	12	310
5		Towerbolt ALU-D25	Aluminium	Stainless Steel	9.5	9291336	300	Pc	12	355
1		Towerbolt ALU-D25	Aluminium	Antique Brass	9.5	9291337	100	Pc	12	212
2		Towerbolt ALU-D25	Aluminium	Antique Brass	9.5	9291338	150	Pc	12	268
3		Towerbolt ALU-D25	Aluminium	Antique Brass	9.5	9291339	200	Pc	12	312
4		Towerbolt ALU-D25	Aluminium	Antique Brass	9.5	9291340	250	Pc	12	368
5		Towerbolt ALU-D25	Aluminium	Antique Brass	9.5	9291341	300	Pc	12	425
1		Towerbolt ALU-ISI-10	Aluminium	Aluminium Anodized	10	9291362	100	Pc	12	67
2		Towerbolt ALU-ISI-10	Aluminium	Aluminium Anodized	10	9291364	150	Pc	12	90
3		Towerbolt ALU-ISI-10	Aluminium	Aluminium Anodized	10	9291365	200	Pc	12	114
4		Towerbolt ALU-ISI-10	Aluminium	Aluminium Anodized	10	9291366	250	Pc	12	137
5		Towerbolt ALU-ISI-10	Aluminium	Aluminium Anodized	10	9291367	300	Pc	12	162
1		Towerbolt ALU-ISI-10	Aluminium	Anodized Stainless Steel	10	9291368	100	Pc	12	80
2		Towerbolt ALU-ISI-10	Aluminium	Anodized Stainless Steel	10	9291369	150	Pc	12	110
3		Towerbolt ALU-ISI-10	Aluminium	Anodized Stainless Steel	10	9291370	200	Pc	12	138
4		Towerbolt ALU-ISI-10	Aluminium	Anodized Stainless Steel	10	9291371	250	Pc	12	168
5		Towerbolt ALU-ISI-10	Aluminium	Anodized Stainless Steel	10	9291372	300	Pc	12	198

New arrival*

Tower Bolt

Stainless Steel & Brass Tower Bolt For Doors



Sr. No.		Description	Material	Finish	Rod dia. (in mm)	Article No.	Size (in mm)	Unit	PU	MRP/Pc
1		Towerbolt STS-D22	Stainless Steel	Antique Brass	9	9291352	100	Pc	12	195
2		Towerbolt STS-D22	Stainless Steel	Antique Brass	9	9291353	150	Pc	12	233
3		Towerbolt STS-D22	Stainless Steel	Antique Brass	9	9291354	200	Pc	12	265
4		Towerbolt STS-D22	Stainless Steel	Antique Brass	9	9291355	250	Pc	12	310
5		Towerbolt STS-D22	Stainless Steel	Antique Brass	9	9291356	300	Pc	12	345
1		Towerbolt STS-SQ15	Stainless Steel	Stainless Steel	9	9291357	100	Pc	12	186
2		Towerbolt STS-SQ15	Stainless Steel	Stainless Steel	9	9291358	150	Pc	12	225
3		Towerbolt STS-SQ15	Stainless Steel	Stainless Steel	9	9291359	200	Pc	12	260
4		Towerbolt STS-SQ15	Stainless Steel	Stainless Steel	9	9291360	250	Pc	12	300
5		Towerbolt STS-SQ15	Stainless Steel	Stainless Steel	9	9291361	300	Pc	12	335
1		Towerbolt BRS-D25	Brass	Polished Brass	9	9291342	100	Pc	12	470
2		Towerbolt BRS-D25	Brass	Polished Brass	9	9291343	150	Pc	12	670
3		Towerbolt BRS-D25	Brass	Polished Brass	9	9291344	200	Pc	12	880
4		Towerbolt BRS-D25	Brass	Polished Brass	9	9291345	250	Pc	12	1,090
5		Towerbolt BRS-D25	Brass	Polished Brass	9	9291346	300	Pc	12	1,310

New arrival*



Bed Fittings

Hepo's range of Bed Storage Systems addresses the need of space-efficiency. It offers a complete and effective solution for accessing the storage spaces below the heavy mattresses with ease. Most Indian households store bed linen, pillows & blankets which are required for seasonal purposes underneath their mattresses in the bed storage.

Hepo's Bed Fittings allow to access the storages with ease and a swift single handed lift movement. The opening angle of the fitting

is also engineered to provide maximum access to the storage space from all sides of the bed.

The Bed Lift Storage System is the answer to all storage needs; it is a smart solution for turning a cluttered master bedroom into a relaxing retreat which allows Complete Opening Function for Ergonomical needs. It is designed specially keeping in mind the current Indian housing scenario and is the perfect way to add more usable living space to your room.



Side Opening Bed Storage



Bed Fittings Fixed to Sides of Storage



Centrally Fixed Fittings for clear sides

Technical Specification

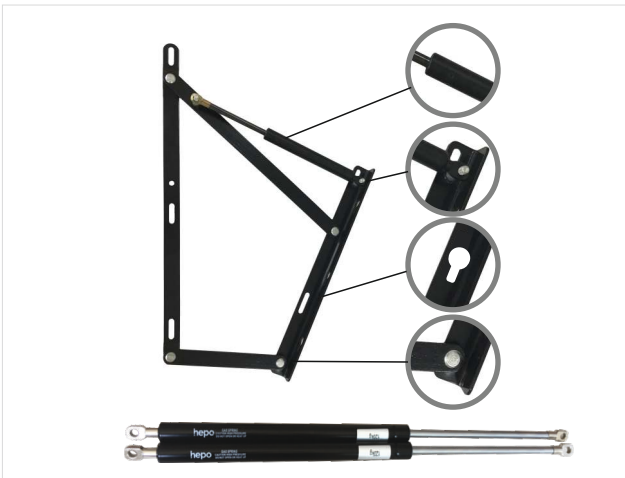

- ▶ Perfect Storage & Space saving
- ▶ Large opening for easy access under the bed
- ▶ Opening from the side or foot of the bed is workable
- ▶ Convenience of use
- ▶ Noiseless and effortless operation
- ▶ International quality mechanism
- ▶ Black Powder Coated finish
- ▶ Backed by Hepo assurance
- ▶ Gas Spring: Passed SGS Test Reliable
- ▶ Quality Effortless Operation
- ▶ Frame Material : Q235
- ▶ Frame Thickness: 5 mm
- ▶ Gas Spring Material: Steel
- ▶ Finish: Powder Coated Black color

Set includes:

- ▶ 1 pair of Bed lift mechanism,
- ▶ Mounting screws & nuts pack
- ▶ 1 pair of Gas spring

Bed Fitting Frame - 1100 mm



- ▶ Frame Material : Q235
- ▶ Frame Thickness : 5 mm
- ▶ Finish: Powder Coated Black color
- ▶ Maximum Opening Angle: 60°
- ▶ Compatible with Gas Spring of 538 mm length
- ▶ Weight carrying capacity of compatible Gas Spring: 70kg



Description	Article no.	Unit	PU	MRP/Set
Bed Fitting Frame - 1100mm	9263455	Set	1	2,764
Gas Spring 538mm / 70Kg	9263461*	Set	1	788

Bed Fitting Frame - 1500 mm



- ▶ Frame Material : Q235
- ▶ Frame Thickness : 5 mm
- ▶ Finish: Powder Coated Black color
- ▶ Maximum Opening Angle : 60°
- ▶ Compatible with Gas Spring of 538 mm length
- ▶ Weight carrying capacity of compatible Gas Spring: 100kg/120kg/150kg



Description	Article no.	Unit	PU	MRP/Set
Bed Fitting Frame -1500 mm	9263457	Set	1	3,193
Gas Spring Plus 538mm / 100Kg	9263462*	Set	1	788
Gas Spring Plus 538mm / 120Kg	9263463*	Set	1	788
Gas Spring Plus 538mm / 150Kg	9264940*	Set	1	1,362

* Gas Spring set to be ordered as per required weight capacity
 * Packaging: Each Bed Fitting and gas spring Set in a separate carton box
 Note: MRP are subject to change any time without prior notice.

Bathroom Accessories

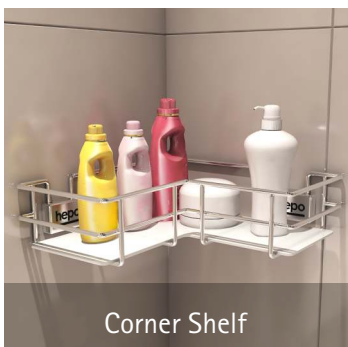

Corner Shelf

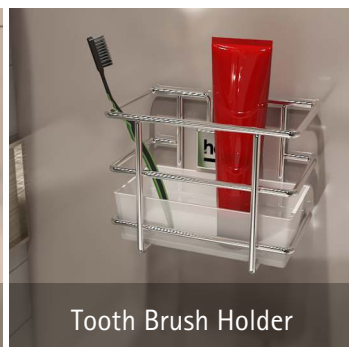

Tooth Brush Holder

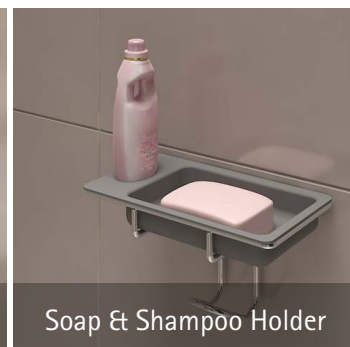

Soap & Shampoo Holder

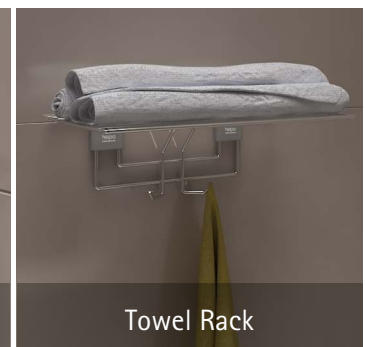

Towel Rack



Tissue Roll Holder



Towel Rail



Clothes Hook



Accessory Shelf



Hand Towel Holder

Hepo takes the definition of a contemporary bathroom a step ahead with its exquisite range of bathroom accessories that impart a sense of style and convenience to bathrooms. The range consists of a set of accessories that provide holistic solutions to every possible storage need in the bathroom. The accessories not only add on style to your bathroom but also enhance the level of convenience.

Bathroom Accessories

Stainless steel accessories with chrome plating
5 years replacement warranty against rusting

hepo



Towel Rail



Hepo Stainless Steel Towel Rails adds a refined touch to the bathroom. It is a cool practical home addition that keeps your towel dry that keeps the sick humid stink at bay. A must for your bathroom, they add the right glamour touch & keep your bathroom free of damp breeding ground for germs and mold.

- ▶ Package contains 1 towel rail, 2 cover caps & 5 wall fixing screws
- ▶ Can hold 2 hand towels

Description	Article No.	Size (WxDxH) mm	MRP/Pc
Towel Rail - 350 mm	9280378	350x100x100	852

Towel Rack



Hepo wall mounted Towel Rack adds the right stylish element to your bathroom. It lets you stack your towels neatly on to it which looks good, gives you great comfort & keeps your bathroom hygienic too!

- ▶ Package contains 1 towel rack, 2 cover caps & 5 wall fixing screws
- ▶ Can hold 3 folded towels on the surface & 3 towels or clothes can be hung

Description	Article No.	Size (WxDxH) mm	MRP/Pc
Towel Rack - 450 mm	9280377	450x250x150	2,466

Clothes Hook



Hepo Clothes Hook is a fascinating and convenient clothes holder fashioned to hold the clothes in the bathroom in style. The product puts an end to the unsightly picture of used and unused clothes lying around, in the bathroom by giving a compact place to hang them.

- ▶ Package contains 1 cloth hook, 2 cover caps & 5 wall fixing screws
- ▶ Can hold 9 nos of clothes or full size towels

Description	Article No.	Size (WxDxH) mm	MRP/Pc
Clothes Hook	9280371	447x55x133	1,138

Bathroom Accessories

Stainless steel accessories with chrome plating
5 years replacement warranty against rusting

hepo



Accessory Shelf



Hepo Accessory Shelf has been modelled to hold daily use assortments. When added to the bathroom ensemble, the linear designed shelf adds a subtle refined touch.

- ▶ Package contains 1 accessory shelf, 1 plastic tray, 2 cover caps & 5 wall fixing screws
- ▶ Can hold a variety in bottles of different sizes

Description	Article No.	Size (WxDxH) mm	MRP/Pc
Accessory Shelf - W300	9280369	300x100x120	1,043
Accessory Shelf - W450	9280370	450x100x120	1,232

Corner Shelf



Hepo Corner Shelf is a sleek corner unit that can hold multiple essential stuff. The product enhances storage space with its L shape component not only in your bathroom but can also be used in other corners of your beautiful house.

- ▶ Package contains 1 corner shelf, 1 plastic tray, 2 cover caps & 5 wall fixing screws
- ▶ Can hold a variety of bottles in different sizes with other articles as well

Description	Article No.	Size(WxDxH) mm	MRP/Pc
Corner Shelf	9280372	300x300x120	1,328

Hand Towel Holder



Hepo Hand Towel Holder is a charming accessory geared to store the towels. The product helps to retain a high level hygiene factor in the bathroom by keeping the towels dry and gives a pleasant contemporary twist to the bathroom landscape.

- ▶ Package contains 1 hand towel holder, 1 cover cap & 3 wall fixing screws
- ▶ Can hold 2 hand towels

Description	Article No.	Size(WxDxH) mm	MRP/Pc
Hand Towel Holder - 220 mm	9280373	220x70x100	568

Bathroom Accessories

Stainless steel accessories with chrome plating
5 years replacement warranty against rusting

hepo



Tooth Brush Holder



Hepo stainless steel Tooth Brush Holder adds the right ambivalent touch to your bathroom, saves the unnecessary utilization of space by toothbrush containers on the basin.

- ▶ Package contains 1 tooth brush holder, 1 plastic tray, 1 cover cap & 3 wall fixing screws
- ▶ Can hold 4-6 toothbrushes, tung cleaner & 1 toothpaste tube / mouth freshener

Description	Article No.	Size (WxDxH) mm	MRP/Pc
Tooth Brush Holder	9280376	150x100x70	757

Soap & Shampoo Holder

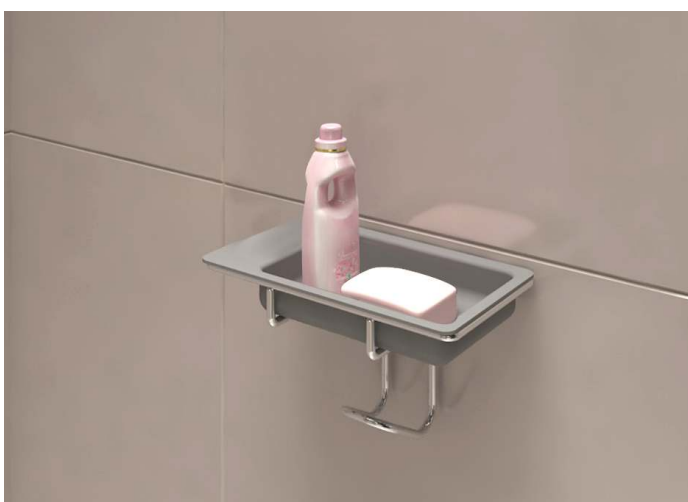

Hepo Soap & Shampoo Holder is another accessory from Hepo that allows you to place your favourite shampoo and soap in a way that is conveniently accessible. The holder prevents the wastage of space on the floor or open spaces that may be taken up in absence of the wall mounted holder.

- ▶ Package contains 1 soap holder, 1 plastic tray, 1 cover cap & 3 wall fixing screws
- ▶ Can hold 1 soap and 1 shampoo bottle or shower gel bottom hook can be hold loofah or bath scrubber

Description	Article No.	Size (WxDxH) mm	MRP/Pc
Soap & Shampoo Holder	9280374	200x115x125	948

Tissue Roll Holder



Hepo Tissue Roll Holder with plastic tray is a suave product that must find a place in all modern bathrooms to maintain that elite factor besides maintaining hygiene within. It rolls the tissues well that comes out with ease while in use.

- ▶ Package contains 1 tissue roll holder, 1 plastic tray, 1 cover cap & 3 wall fixing screws
- ▶ Can hold 1 tissue roll and some other articles on plastic tray

Description	Article No.	Size (WxDxH) mm	MRP/Pc
Tissue Roll Holder	9280375	200x105x110	1,138

Connecting Fittings

Cam, Steel Dowel & Socket



Cam

- Technical Detail:
- ▶ Drilling diameter 15 mm
 - ▶ Drilling depth 13 mm
 - ▶ Available for 15/18 mm panel thickness
 - ▶ Surface material: Nickel Plating

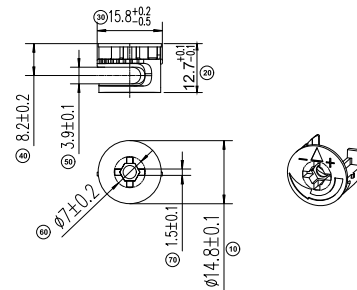

Description	Unit	Article no	PU	MRP/Pc
Zinc Cam 15/18D-NI, Allen & PH	Pc	9290887	3000	6.15

Steel Dowel

- Technical Detail:
- ▶ Dowel Length: 41 mm
 - ▶ Drilling depth: 34 mm
 - ▶ Drilling diameter: 8 mm
 - ▶ Available with unmovable plastic part
 - ▶ Surface material: Zinc Plating
 - ▶ Finish: Gray

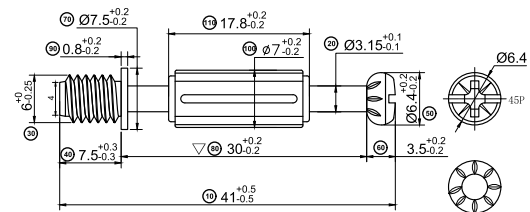

Description	Unit	Article no	PU	MRP/Pc
M6*34 Dowel, 3 in one, PZ2, Galvanizing	Pc	9289656	3000	2.15

Socket

- ▶ Inner thread: M6
- ▶ Drilling diameter 10 mm
- ▶ Drilling depth: 11.5 mm
- ▶ Available for 15/18 mm panel thickness
- ▶ Finish: White

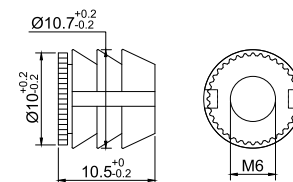

Description	Unit	Article no	PU	MRP/Pc
Nylon Socket, Ø10.8x11, Inner M6 hole	Pc	9289732	3000	0.75

Connecting Fittings

Wooden Dowel, Hex Metal Socket ZP



Wooden Dowel

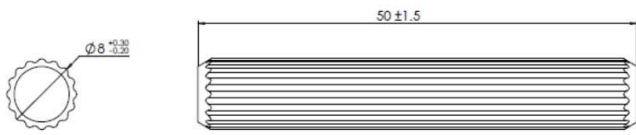

Wooden Dowel 8x50mm

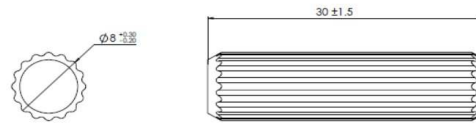

Wooden Dowel 8x30mm

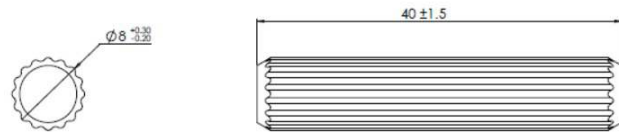

Wooden Dowel 8x40mm

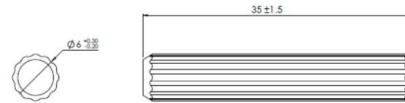

Wooden Dowel 6x35mm

Description	Unit	Article no	PU	MRP/Pc
Wooden Dowel 8.0x40mm	Pc	9102465	2000	0.92
Wooden Dowel 8.0x30mm	Pc	9290706	2000	0.84
Wooden Dowel 8.0x50mm	Pc	9290707	2000	1.27
Wooden Dowel 6.0x35mm	Pc	9290708	2000	0.72

Hex Metal Socket ZP



Material used: Zinc Alloy
Drive: Hex Socket

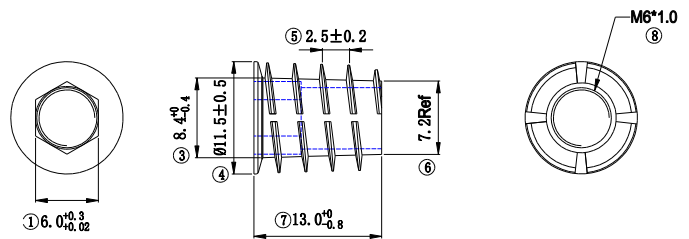

Hex Metal socket M6x13

Description	Unit	Article no	PU	MRP/Pc
Hex Metal socket M6x13 ZP	Pc	9290695	6000	3.75
Hex Metal socket M6x15 ZP	Pc	9290696	6000	4.10
Hex Metal socket M6x20 ZP	Pc	9290698	4500	5.50
Hex Metal socket M8x18 ZP	Pc	9290702	3500	5.90

Connecting Fittings

D- Nut (Steel) & Insert Socket full threaded L-Bracket



D-Nut (Steel)



- ▶ Material used: Steel
- ▶ Available in HEX drive
- ▶ Available in Regular/Metric thread
- ▶ Available Finish: Chrome, Blue zinc (ZP, Cr3+)
- ▶ Available with bulk packing
- ▶ Tested for 48 Hrs Salt Spray against rusting

Stell screw nut					
Data	M6*13	M6*15	M6*18	M6*20	M6*25
A(L)	13 ⁺¹ ₋₁	15 ^{+1.5} _{-1.5}	18 ^{+1.5} _{-1.5}	20 ^{+1.5} _{-1.5}	25 ^{+1.5} _{-1.5}
B(D)	11.8 ^{+0.5} _{-0.5}	11.8 ^{+0.5} _{-0.5}	11.8 ^{+0.5} _{-0.5}	11.8 ^{+0.5} _{-0.5}	11.8 ^{+0.5} _{-0.5}
C(D)	10.5 ^{+0.5} _{-0.5}	10.5 ^{+0.5} _{-0.5}	10.5 ^{+0.5} _{-0.5}	10.5 ^{+0.5} _{-0.5}	10.5 ^{+0.5} _{-0.5}
D(inne hex)	6.1 ^{+0.2} _{-0.2}	6.1 ^{+0.2} _{-0.2}	6.1 ^{+0.2} _{-0.2}	6.1 ^{+0.2} _{-0.2}	6.1 ^{+0.2} _{-0.2}

Steel screw nut					
data	M8*13*12.5	M8*15*12.5	M8*18*12.5	M8*20*12.5	M8*25*12.5
A(Length)	13 ⁺¹ ₋₁	15 ^{+1.5} _{-1.5}	18 ^{+1.5} _{-1.5}	20 ^{+1.5} _{-1.5}	25 ^{+1.5} _{-1.5}
B(Diameter)	14 ^{+0.5} _{-0.5}	14 ^{+0.5} _{-0.5}	14 ^{+0.5} _{-0.5}	14 ^{+0.5} _{-0.5}	14 ^{+0.5} _{-0.5}
C(Diameter)	12.5 ^{+0.5} _{-0.5}	12.5 ^{+0.5} _{-0.5}	12.5 ^{+0.5} _{-0.5}	12.5 ^{+0.5} _{-0.5}	12.5 ^{+0.5} _{-0.5}
D(inner hex)	8.08 ^{+0.2} _{-0.2}	8.08 ^{+0.2} _{-0.2}	8.08 ^{+0.2} _{-0.2}	8.08 ^{+0.2} _{-0.2}	8.08 ^{+0.2} _{-0.2}

Metal socket - Steel	Dimension	Unit	Article No.	PU	MRP/Pc
D-Nut(Steel) M6x13, ZP Cr3+	M6x13	Pc	9296712	3500	2.50
D-Nut(Steel) M6x15, ZP Cr3+	M6x15	Pc	9296713	3000	2.75
D-Nut(Steel) M6x18, ZP Cr3+	M6x18	Pc	9296714	2500	3.15
D-Nut(Steel) M6x20, ZP Cr3+	M6x20	Pc	9296715	2500	3.35
D-Nut(Steel) M6x25, ZP Cr3+	M6x25	Pc	9296716	2000	4.15
D-Nut(Steel) M8x13, ZP Cr3+	M8x13	Pc	9296717	3000	3.05
D-Nut(Steel) M8x15, ZP Cr3+	M8x15	Pc	9296718	2500	3.35
D-Nut(Steel) M8x18, ZP Cr3+	M8x18	Pc	9296719	2000	3.65
D-Nut(Steel) M8x20, ZP Cr3+	M8x20	Pc	9296720	2000	4.15
D-Nut(Steel) M8x25, ZP Cr3+	M8x25	Pc	9296721	1500	4.95

T-nut



- Material : Steel
 Finish : Zinc
 Drive : Metric
 Packing : Retail

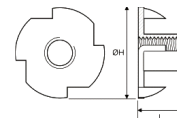

Dimension Drawing

S.No.	Description	Dimension	Unit	Article No.	PU	MRP/100
1	T-nut Ø19	M 6 x 9	Pc	521103460	5500	294
2	T-nut Ø 22	M8 x 12	Pc	521103660	3500	419

L-Bracket

S.No.	Description	Unit	Article No.	PU	MRP/Pc
1	L-Bracket 31x31 mm	Pc	79665	1000	15
2	L-Bracket 41x41 mm	Pc	25197	100	16

Screws

HePo offers wide range of screws in India ideally suitable for all type of wood, plastic, masonry and sheet metal.

HePo provides complete range of woodworking and building and construction screw i.e. Chipboard screw, Drywall screws (black phosphate), Self-drilling screws, Self-tapping screw, Handle fixing screws, Truss head and roofing screws. HePo screws are made from hardened steel. What differentiates HePo screws from other available in market are:

Saw Thread - Gives better and faster cutting strength for the screw inside the material. Thus, a carpenter has to use less force and effort during drilling.

Pozi Drive - It has eight times better grip than a slotted head and two times better than Philips head, allowing greater torque.

Sharp Tip - Optimized tip geometry for better positioning and stacking of the screw, even on hard surface

High Thread Pitch - Gives faster drive and better contact with the substrate thereby reducing the time of installation.

Packaging - HePo screws are available in different pack sizes i.e. bulk/retail/small pack as per the customer needs.

Available Screws - Zinc Coated, Stainless Steel, Blackodized, Special Screws & Accessories

Pozi Drive Head provide a greater driving surface & decrease wear

Saw thread for faster cutting strength of the screw inside material

Toothed thread design for minimal driving torque

Sharp tip for improved positioning and starting on hard surfaces

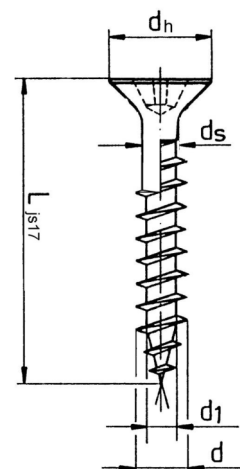

d : Thread diameter
d₁ : Core diameter
d_s : Shank diameter
L : Screw length
d_h : Head diameter

Naming Convention for Chipboard Screws

Consider 4 x 20

4 is the diameter of the thread in 'mm' (Including the thread)
20 is the length of the screw in 'mm'

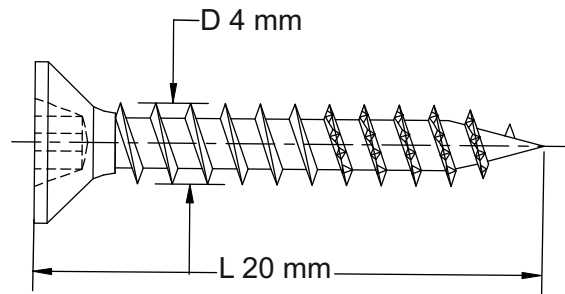

Naming Convention for Machine Screws

Consider M4x26

4 is the diameter in 'mm'
26 is the length of the screw in 'mm'

Specifying the Screw:

Panel thickness + 6 mm to pierce into the handle
e.g: For a 16 mm Panel, 22 mm screw length can be suggested to fix a handle, knob etc

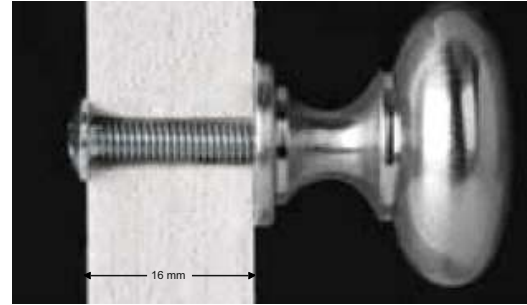

Screws : Nomenclature

As per Screw Heads



Slotted Head

Phillips Head

Pozi Drive

As per Screw Head Shape

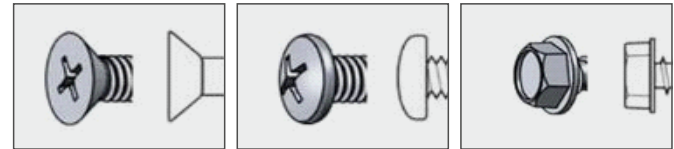

Countersunk Head

Pan Head

Hexagonal Head

Indian Market follows imperial system (Gauge & Inch) Which allows suppliers to sell shorter screws against any required size

Conversion Chart- Imperial System to Metric System

Diameter		Length	
Gauge No.	mm	Inch	mm
2	2	1/4	6
3	2.5	3/8	10
4	3	1/2	12
5	3	5/8	16
6	3.5	3/4	20
7	4	1	25
8	4	1 1/4	30
9	4.5	1 1/2	40
10	5	1 3/4	45
12	5.5	2	50
12	6	2 1/4	55
14	8	2 1/2	60
		2 3/4	70
		3	75
		3 1/2	90
		4	100
		4 1/2	110
		5	130
		6	150

Note: There is tradition of citing screw diameter in gauge & screw length in inches

Screw Portfolio

Screws	Page No.
Stainless Steel Screws	
CSK Saw Thread Magnetic & Non-magnetic Screw	32
Carbon Steel Screws	
CSK Saw Thread Screw	33
Pan Head Saw Thread Screw	34
Self Drilling Screw with Rib & with Washer	35
Handle Fixing Screw	35
Black Screws	
Blackodised CSK Chipboard Screw	36
Blackodised Pan Head Chipboard Screw	36
Drywall Screw	37
Truss Head Screw	37
Special Purpose Screws	
Countersunk Full Thread Screw	38-41
Accessories	
Drive Bit & Screw Driver	42

Carbon Steel Screw

CSK Saw Thread Screw

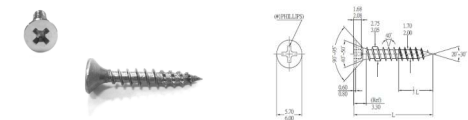
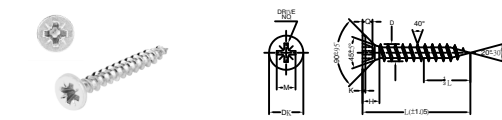

CSK Saw Thread Philips Drive Screw						CSK Saw Thread Pozi Drive Screw				
										
Material : Steel Drive : Philips Finish : Zinc Coated Thread : Saw Head : Countersunk Packing : Retail						Material : Steel Drive : Pozi Finish : Zinc Coated Thread : Saw Head : Countersunk Packing : Retail				
Philips Drive						Pozi Drive				
S.No.	Dimension	Size	Article No.	Unit	PU	MRP/100	Article No.	Unit	PU	MRP/100
1	Ø3 x 10	10/5	-	-	-	-	916936900*	Pc	1000	62*
2	3.0x12	12/5	928903800	Pc	1000	36	916237800	Pc	1000	63
3	3.0x16	16/5	928908900	Pc	1000	42	916937000	Pc	1000	64
4	3.5x12	12/6	928909400	Pc	1000	47	914809200	Pc	1000	64
5	3.5x16	16/6	928909500	Pc	1000	50	913798000	Pc	1000	68
6	3.5x20	20/6	928909600	Pc	1000	59	915382000	Pc	1000	73
7	3.5x25	25/6	928909800	Pc	1000	63	916237900	Pc	1000	81
8	3.5x30	30/6	928910000	Pc	1000	69	916238000	Pc	1000	95
9	3.5x35	35/6	928910100	Pc	900	79	916937100	Pc	1000	103
10	3.5x40	40/6	928910200	Pc	800	89	916238100	Pc	500	116
11	4.0x12	12/8	928910300	Pc	1000	50	916937200	Pc	1000	73
12	4.0x16	16/8	928910400	Pc	800	59	913799200	Pc	1000	82
13	4.0x20	20/8	928910600	Pc	1000	69	913799100	Pc	1000	86
14	4.0x25	25/8	928910700	Pc	900	77	913799300	Pc	1000	97
15	4.0x30	30/8	928910800	Pc	800	90	914027200	Pc	1000	112
16	4.0x35	35/8	928911000	Pc	600	104	914027400	Pc	500	130
17	4.0x40	40/8	928911200	Pc	600	116	914027500	Pc	500	141
18	4.0x45	45/8	928911400	Pc	500	129	914027600	Pc	500	153
19	4.0x50	50/8	928911600	Pc	400	141	916937300	Pc	500	165
20	Ø4.5 x 16	16/9	-	-	-	-	914027700*	Pc	1000	97*
21	Ø4.5 x 20	20/9	-	-	-	-	916937400*	Pc	1000	105*
22	Ø4.5 x 25	25/9	-	-	-	-	913799400*	Pc	500	130*
23	Ø4.5 x 30	30/9	-	-	-	-	913799500*	Pc	500	147*
24	Ø4.5 x 35	35/9	-	-	-	-	913799600*	Pc	500	167*
25	Ø4.5 x 40	40/9	-	-	-	-	913799700*	Pc	500	178*
26	Ø4.5 x 50	50/9	-	-	-	-	913799800	Pc	200	236
27	5.0x50	50/10	928911700	Pc	300	232	914809300	Pc	200	297
28	5.0x60	60/10	928911800	Pc	200	270	915382100	Pc	200	341
29	5.0x70	70/10	928911900	Pc	200	320	915382200	Pc	200	407
30	5.0x80	80/10	928912000	Pc	200	360	916937600	Pc	100	489
31	5.0x90	90/10	928912100	Pc	100	405	916937800	Pc	100	588
32	5.0x100	100/10	928912200	Pc	100	445	916938000	Pc	100	685

Carbon Steel Screw

Pan head Saw Thread Screw

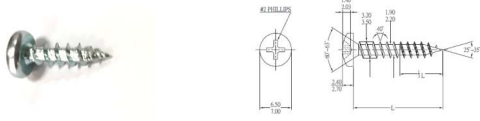
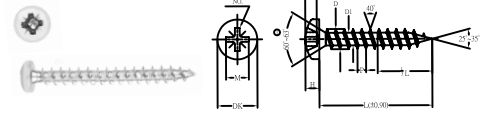

			Pan Head Saw Thread Philips Drive Screw				Pan Head Saw Thread Pozi Drive Screw			
										
			Material : Steel		Drive : Philips		Material : Steel		Drive : Pozi	
			Finish : Zinc Coated		Thread : Saw		Finish : Zinc Coated		Thread : Saw	
			Head : Pan Head		Packing : Retail		Head : Countersunk		Packing : Retail	
			Philips Drive				Pozi Drive			
S.No.	Dimension	Size	Article No.	Unit	PU	MRP/100	Article No.	Unit	PU	MRP/100
1	Ø3.0 x 12	-	-	-	-	-	916938100	Pc	1000	72
2	Ø3.0 x 16	-	-	-	-	-	916938200	Pc	1000	75
3	Ø3.5 x 12	12/6	928912300	Pc	20000	37	916938300	Pc	1000	72
4	Ø3.5 x 16	16/6	928912400	Pc	16000	39	916938400	Pc	1000	75
5	Ø3.5 x 20	-	-	-	-	-	916938500	Pc	1000	83
6	Ø4.0 x 16	-	-	-	-	-	913799900	Pc	1000	82
7	Ø4.0x20	16/8	928912500	Pc	11000	45	-	-	-	-
8	Ø4.0 x 25	20/8	928912600	Pc	10000	53	914028200	Pc	1000	101
9	Ø4.0 x 30	-	-	-	-	-	916938600	Pc	500	130
10	Ø4.0 x 35	-	-	-	-	-	916938700	Pc	500	147
11	Ø4.0 x 40	-	-	-	-	-	916938800	Pc	500	162
12	Ø4.0 x 45	-	-	-	-	-	916938900	Pc	200	178
13	Ø4.0 x 50	-	-	-	-	-	916939000	Pc	200	196
14	Ø4.5 x 16	-	-	-	-	-	913800000	Pc	500	108
15	Ø4.5 x 20	-	-	-	-	-	913802100	Pc	500	118
16	Ø5.0 x 50	-	-	-	-	-	916939100	Pc	200	296
17	Ø6.0 x 35	-	-	-	-	-	916939200	Pc	200	339
18	Ø6.0 x 50	-	-	--	-	-	916939300	Pc	200	437

Black Screws

CSK & Pan Head Regular Thread Chipboard Screws



Blackodised CSK Chipboard Screw



Material : Steel
 Finish : Blackodised
 Head : Countersunk
 Drive : Pozi
 Thread : Regular
 Packing : Retail/Industrial

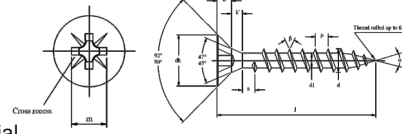

Retail Packing

Industrial Packing

S.No.	Dimension	Size	Article No.	Unit	PU	MRP/100	Article No.	Unit	PU	MRP/100
1	Ø3 X16	16/5	541212030	Pc	1000	48*	-	-	-	-
2	Ø3.5 x 12	12/6	541212040	Pc	1000	49*	921510800	Pc	31000	34
3	Ø3.5 x 16	16/6	541212050	Pc	1000	60	921510900	Pc	25000	38
4	Ø3.5 x 20	20/6	541212060	Pc	1000	63	921511000	Pc	22000	42
5	Ø3.5 x 25	25/6	541212070	Pc	1000	66	921511100	Pc	17000	51
6	Ø3.5 x 30	30/6	541212080	Pc	1000	74	921511200*	Pc	14500	58*
7	Ø3.5 x 35	35/6	541212090	Pc	1000	82	-	-	-	-
8	Ø4.0 x 16	16/8	541212120	Pc	1000	66	923663900	Pc	19000	54
9	Ø4.0 x 20	20/8	541212130	Pc	1000	74	923664100*	Pc	16000	62*
10	Ø4.0 x 25	25/8	541212140	Pc	1000	82	923664200*	Pc	13000	69*
11	Ø4.0 x 30	30/8	541212150	Pc	1000	96	923664300*	Pc	11000	85*
12	Ø4.0 x 35	35/8	541212160	Pc	500	109	923664400	Pc	10000	97
13	Ø4.0 x 40	40/8	541212170	Pc	500	121	921511300	Pc	8000	86
14	Ø4.0 x 45	45/8	541212180*	Pc	500	131*	-	-	-	-
15	Ø4.0 x 50	50/8	541212190	Pc	500	146	-	-	-	-
16	Ø5.0 x 50	50/10	541212230	Pc	200	231	921511400*	Pc	4500	157*
17	Ø5.0 x 60	60/10	541212240	Pc	200	268	-	-	-	-
18	Ø5.0 x 70	70/10	541212250	Pc	200	313	-	-	-	-

Blackodised Pan Head Chipboard Screws



Material : Steel
 Finish : Blackodised
 Head : Pan Head
 Drive : Pozi
 Thread : Regular
 Packing : Retail/Industrial

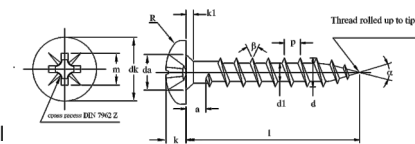

Retail Packing

Industrial Packing

S.No.	Dimension	Size	Article No.	Unit	PU	MRP/100	Article No.	Unit	PU	MRP/100
1	Ø3.5 x 12	12/6	541222040	Pc	1000	62	921511500	Pc	22000	43
2	Ø3.5 x 16	16/6	541222050	Pc	1000	77	921511600	Pc	20000	45
3	Ø3.5 x 25	25/6	-	-	-	-	921512700	Pc	15000	56
4	Ø4 x 16	16/8	541222120	Pc	1000	94	923664600	Pc	15000	73
5	Ø4 x 20	20/8	541222130	Pc	1000	102	923664700	Pc	12000	82
6	Ø4 x 25	25/8	541222140	Pc	1000	113	923664800	Pc	10000	91
7	Ø4 x 30	30/8	541222150	Pc	500	127	923664900	Pc	9000	105
8	Ø4 x 35	35/8	-	-	-	-	923665000	Pc	8000	114
9	Ø4 x 40	40/8	-	-	-	-	923665100	Pc	7000	126
10	Ø4 x 50	50/8	-	-	-	-	923665200	Pc	5500	149

Black Screws

Drywall Screw & Truss Head Screws



Drywall Screw - Retail Packing



Material : Steel
 Finish : Black
 Drive : Phillips Drive
 Thread : Fine Thread
 Packing : Retail

S.No.	Dimension	Size	Article No.	Unit	PU	MRP/100
1	3.5x20	20/6	926247900	Pc	1000	51
2	3.5x25	25/6	926248000	Pc	1000	59
3	3.5x30	30/6	926251100	Pc	1000	71
4	3.5x35	35/6	926251200	Pc	1000	79
5	3.5x40	40/6	926251300	Pc	500	85
6	3.5x45	45/6	926251400	Pc	500	96
7	3.5x50	50/6	926251500	Pc	500	105

Dimension Drawing

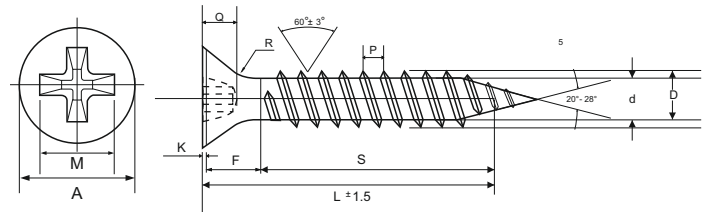

Details	Head Dia. A	F	Major Dia. D	Minor Dia. d	K	Pitch P	Recess Depth Q	R	Recess Width M	N	Torque Nm
#6 (3.5 mm)	8	4.5	3.4	2	0.5	1.4	2.55	4.5	4.5	0.81	2.8 min
	8.5	7	3.6	2.3	0.8	1.7	2.93	5	5.1		

Truss Head screws in Retail Packing



Material : Steel
 Finish : Black
 Head : Truss Head
 Drive : Philips
 Thread : Regular
 Packing : Retail

S.No.	Dimension	Size	Article No.	Unit	PU	MRP/100
1	Ø4.0 x 13	13/8	928060300	Pc	1000	50
2	Ø4.0 x 16	16/8	928060400	Pc	1000	52
3	Ø4.0 x 20	20/8	928060500	Pc	1000	65
4	Ø4.0 x 25	25/8	928060600	Pc	1000	78
5	Ø4.0 x 30	30/8	928060700	Pc	1000	91
6	Ø4.0 x 40	40/8	928060800	Pc	500	116
7	Ø4.0 x 50	50/8	928060900	Pc	500	142
8	Ø5.0 x 50	50/10	928061000	Pc	500	225

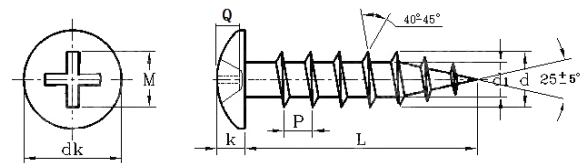

Tolerance Size	H+/-0.5	Q	K (REF.)	d1	d	P	M+/-0.5	DK	Drive no.	Breaking Torque (Min)	L
M4	4	2.1	2.2	2.25	3.75	1.69	4.2	8.5	PH2	34	16-50 MM ±1.5
		2.6	2.6	2.5	4	1.91		9			
M5	5	2.1	2.8	2.8	4.7	2.07	4.2	10.8	PH2	62	16-100 MM ±1.5
		2.6	3.2	3.1	5	2.33		11.4			

*Subject to stock availability/ on request basis

Special Purpose Screws

Countersunk Full Thread Screws



Zinc Countersunk Full Thread - Retail Packing

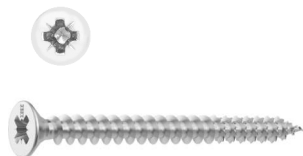

Material : Steel hardened
 Finish : Bright zinc plated
 Head : Countersunk
 Drive : Pozi Drive
 Packing : Retail

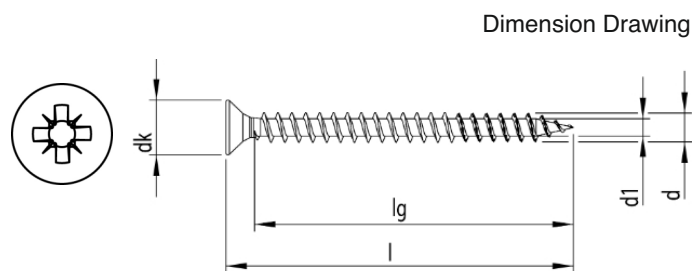

S.No.	Dimension	Gauge	Article No.	Unit	PU	MRP/100
1	Ø3.0 x 10	5	118017691 *	Pc	1000	156*
2	Ø3.0 x 12	5	916300400 *	Pc	1000	156*
3	Ø3.5 x 16	6	118002300	Pc	1000	154
4	Ø3.5 x 20	6	916300500	Pc	1000	168
5	Ø3.5 x 25	6	118002100 *	Pc	1000	178*
6	Ø3.5 x 30	6	118002200 *	Pc	1000	193*
7	Ø4.0 x 12	8	118012500 *	Pc	1000	181*
8	Ø4.0 x 16	8	118015100	Pc	1000	181
9	Ø4.0 x 20	8	118016800	Pc	1000	198
10	Ø4.0 x 25	8	118016900	Pc	1000	220
11	Ø4.0 x 30	8	118001700	Pc	1000	242
12	Ø4.0 x 35	8	118017100	Pc	500	286
13	Ø4.0 x 40	8	118002600 *	Pc	500	308*
14	Ø4.0 x 45	8	118001900 *	Pc	500	352*
15	Ø4.0 x 50	8	118001800	Pc	500	399
16	Ø4.5 x 20	9	118002800*	Pc	1000	265*
17	Ø4.5 x 25	9	118044647*	Pc	500	299*
18	Ø4.5 x 30	9	118015951*	Pc	500	318*
19	Ø4.5 x 40	9	118016214*	Pc	500	374*
20	Ø4.5 x 45	9	118016795*	Pc	500	495*
21	Ø4.5 x 50	9	118015299*	Pc	200	508*
22	Ø4.5 X 55	9	118016087*	Pc	200	768*
23	Ø4.5 x 60	9	118016087*	Pc	200	654*
24	Ø4.5 x 70	9	118016958*	Pc	200	894*
25	Ø5.0 x 50	10	922204200	Pc	200	593
26	Ø5.0 x 70	10	118001600	Pc	200	934
27	Ø5.0 x 90	10	915541400	Pc	200	1349
28	Ø6.0 x 40	12	118002000	Pc	200	886*

Size (dxl) mm	Thread length lg (mm)	Head diameter dk (mm)
3x12	9	5.9
3.5x16	13	6.9
3.5x20	16	6.9
3.5x25	21	6.9
3.5x30	26	6.9
4x16	12	7.9
4x20	15	7.9
4x25	20	7.9
4x30	25	7.9
4x35	30	7.9
4x40	35	7.9
4x45	40	7.9
4x50	45	7.9
4.5x20	15	8.9
4.5x25	20	8.9
4.5x30	25	8.9
4.5x40	35	8.9
4.5x45	40	8.9
4.5x50	45	8.9
4.5x55	50	8.9
5x50	44	9.6
5x70	60	9.6
6x40	33	11.6

Available on request

www.hepoindia.com

Countersunk Head			Hardened Steel		
PRODUCT	DESCRIPTION	FINISH	SIZE		SKU
			Diameter	Length	
	PZD, full threaded	bright zinc plated	3.5-6.0	20-70	33
	PZD, with milling ribs, part threaded	bright zinc plated	3.5-6.0	35-180	27
	PZD, full threaded	yellow zinc plated	3.5-6.0	20-70	33
	PZD, with milling ribs, part threaded	yellow zinc plated	3.5-6.0	35-180	28
	T-Drive, full threaded	bright zinc plated	3.5-6.0	20-70	35
	T-Drive, with milling ribs, part threaded	bright zinc plated	3.5-6.0	30-300	45
	T-Drive, with milling grooves, part threaded	bright zinc plated	8.0-10.0	80-500	41
	T-Drive, full threaded	yellow zinc plated	3.5-6.0	20-70	33
	T-Drive, with milling ribs, part threaded	yellow zinc plated	3.5-6.0	30-300	45
Countersunk head Full threaded screws With milling grooves					
	T-Drive, full threaded	bright zinc plated	8.0-10.0	120-380	21
Flange head screws					
	T-Drive, full threaded	bright zinc plated	6.0-10.0	40-120	11
	T-Drive, part threaded	bright zinc plated	6.0-10.0	100-400	39

Available on request

Countersunk Head Screw - Therm					
PRODUCT	DESCRIPTION	FINISH	SIZE		SKU
			Diameter	Length	
	T-Drive, secondary threaded	bright zinc plated	8.0-10.0	160-500	16
Cylinder Head Screw - CombiConnect					
	T-Drive, double threaded	bright zinc plated	6.5-8.5	100-400	14
Flange Head Connector Screws					
	T-Drive, double threaded	bright zinc plated	10.0	120-160	2
Countersunk Head with Milling Grooves					
	T-Drive, full threaded	bright zinc plated	8.0-10.0	120-180	5
Flange Head Post Screw					
	T-Drive, full threaded	HP-coated	6.0-8.0	40-60	6
Raised Countersunk Head Glass Strip Screw With Milling Ribs					
	T-Drive, part threaded	bright zinc plated	3.5	30-60	5
	T-Drive, part threaded	yellow zinc plated	3.5	30-40	3
Countersunk Head Fitting Screw					
	PZD, full threaded	bright zinc plated	4.5	40	1

Countersunk Head			Stainless steel		
PRODUCT	DESCRIPTION	FINISH	SIZE		SKU
			Diameter	Length	
	PZD, full threaded	A2 self-colour, coated	3.5-5.0	20-70	17
	T-Drive, with milling ribs, part threaded	A2 self-colour, coated	3.5-8.0	30-400	42
Flange Head					
	T-Drive, full threaded	A2 self-colour, coated	6.0-8.0	40-120	11
	T-Drive, part threaded	A2 self-colour, coated	6.0-8.0	100-300	11
Flange Head-T Solar					
	T-Drive, secondary threaded	A2 self-colour, coated	8.0	240-360	3
Raised Countersunk Head Glass Strip Screw With Milling Ribs					
	T-Drive, part threaded	A2 self-colour, coated	3.5	40	1
Countersunk Head Fitting Screw					
	PZD, full threaded	A2 self-colour, coated	4.5	40	1
Countersunk Head Decking Screws			Stainless steel		
Countersunk Head Decking Screws With Milling Ribs					
	T-Drive, part threaded	A2 self-colour, coated	5.0	50-80	4
	T-Drive, part threaded	A2 self-colour, coated	5.0	40-80	5
Raised Countersunk Head Decking Screws					
PRODUCT	DESCRIPTION	FINISH	SIZE		SKU
			Diameter	Length	
	T-Drive, secondary threaded	A2 self-colour, coated	5.0	50-80	4
	T-Drive, secondary threaded	A2 self-colour, coated	5.0	40-80	5

Available on request

Accessories

Drive Bit & Screw Driver



Screw - Drive - Bit Pozi Drive



Material : Steel hardened
 Finish : Black
 Drive : Pozi Drive

S.No.	Description	Suitable for	Article No.	Unit	PU	MRP/Pc
1	Pozi Drive Size 1	≤ 3 mm dia	915372300	Pc	10	170
2	Pozi Drive Size 2	3.5 - 5 mm dia	915372600	Pc	10	170
3	Pozi Drive Size 3	≥ 5 mm dia	915372700	Pc	10	170

Drive Bit - 65 mm (Both Side) Pozi Drive



Material : Steel hardened
 Finish : Black
 Drive : Pozi Drive

S.No.	Description	Suitable for	Article No.	Unit	PU	MRP/Pc
1	PZD -1 Screwdrive bits H1/4*65mm PZ1	≤ 3 mm dia	925467100	Pc	10	80
2	PZD -2 Screwdrive bits H1/4*65mm PZ2	3.5 - 5 mm dia	925467200	Pc	10	80
3	PZD -3 Screwdrive bits H1/4*65mm PZ3	≥ 5 mm dia	925467300	Pc	10	80

Drive Bit - 65mm (Both Side) Phillips Drive



Material : Steel hardened
 Finish : Black
 Drive : Phillips Drive

S.No.	Description	Suitable for	Article No.	Unit	PU	MRP/Pc
1	PHD - 2 Screw Drive Bits H1 / 4*65mm PH2	3.5 - 5 mm dia	927324600	Pc	10	80

Screw Driver



Material : Steel hardened
 Drive : Pozi Drive

S.No.	Description	Suitable for	Dimension	Article No.	Unit	PU	MRP/Pc
1	Screws Driver	3.5 - 5 mm dia	PZ 2	919326000	Pc	1	200



Hardware for Professionals

Contact Us

Ahmedabad	7304407551
Bangalore	7338183871
Bangalore	9844639090
Bhubaneshwar	9938988868
Chennai	9739538886
Coimbatore	9061936699
Delhi	8287257534
Hyderabad	9947420958
Indore	7869271060
Jaipur	8657512894
Kanpur	8657514175
Lucknow	9696578877
Mumbai	9545876760
Nagpur	9960237771
NCT/UCT	9910117185
Patiala	9136016414
Patna	8657505171
Pune	9152010580
Vijawada	9704578837

Registered Office:

Hepo India Private Limited
A-26/4, 1st floor,
Mohan Co-operative Industrial Estate,
New Delhi - 110 044
Phone: +91 11 4889 4000, 4889 4005
Fax: +91 11 4889 4044

Head Office:

Hepo India Private Limited
402, 4th floor, Durolite House,
Opp. SAB TV, New Link Road,
Andheri (West), Mumbai - 400 053
Phone: +91 22 2674 3289/3356/4089
Fax: +91 22 2674 3267

Enquiry & Customer Services

Toll Free : 1800 209 2096 (office hours)
customer_services@hepoindia.com
www.hepoindia.com

